

DUPLEX R5

compact ventilation units with the possibility of air circulation for ventilation, cooling and warm-air heating

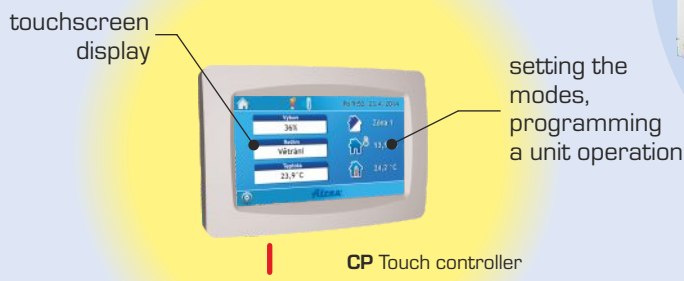

CP TOUCH CONTROLLER



DUPLEX R5 series units are released for foreign markets only in combination with heat pump connected to DX coil for cooling or heating (reverse mode) and are not allowed as a sole and/or primary heating source. **Other applications are not allowed at this moment.**

DUPLEX RB5

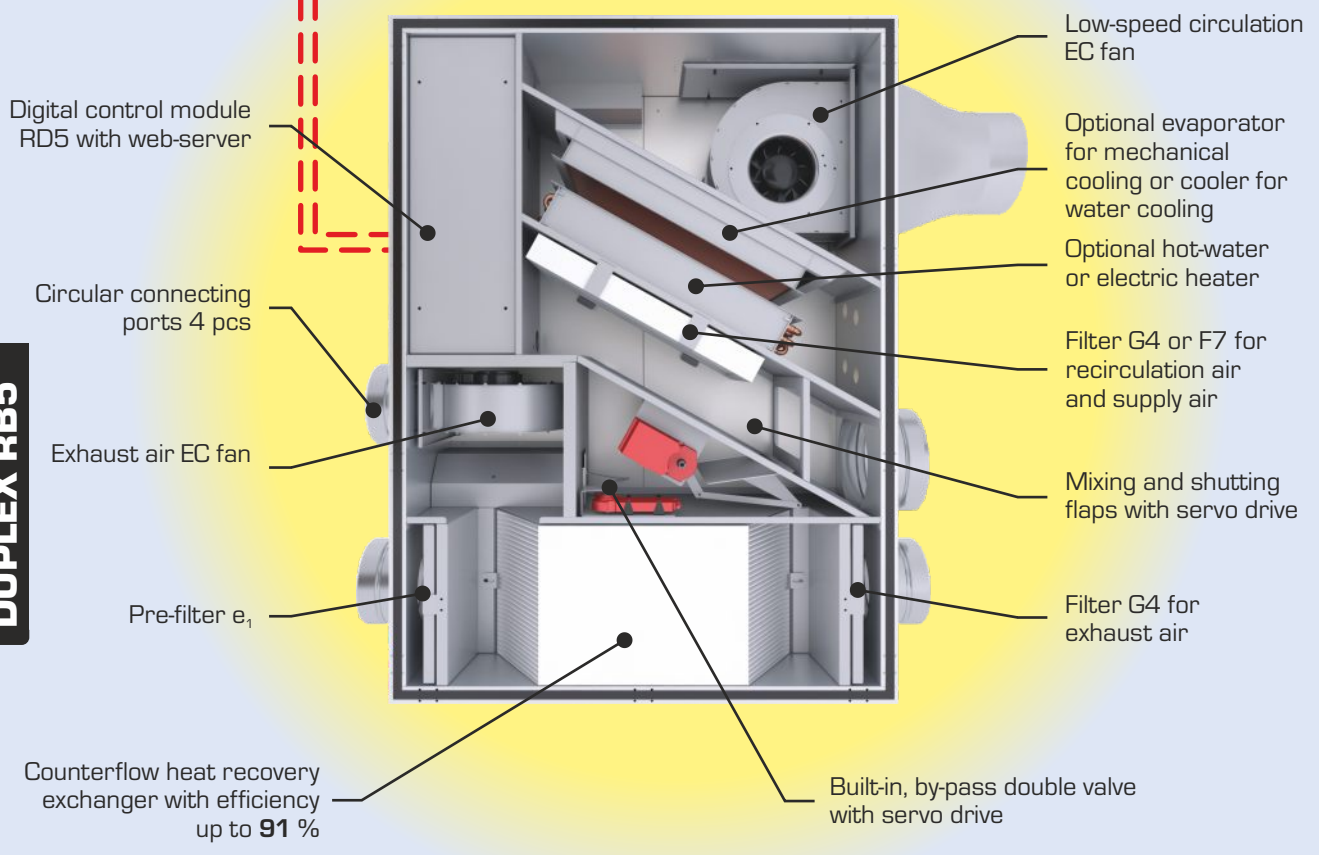

RESIDENTIAL VENTILATION & HEATING

ATREA s.r.o., Čs. armády 32
466 05 Jablonec n. Nisou
Česká republika



Tel.: +420 483 368 133

E-mail: atrea@atrea.eu

www.atrea.eu

ATREA VENTILATION AND HEATING SYSTEM

ATREA VENTILATION AND HEATING SYSTEM

System description

The HVAC system with the DUPLEX R5 series unit provides balanced ventilation with heat recovery in all the installation versions. The properly designed ventilation system provides fresh filtered air supply to each room and kitchen and at the same time, exhaust of effluent air from sanitary facilities, toilets, bathrooms, and kitchens. Owing to the unique system of inside air circulation throughout the object, it is possible to ensure afterheating after recovery, distribution of internal heat gains throughout the object, cooling or warm-air heating without necessity for an additional heating system.

The company ATREA offers this system as a complete construction set, consisting of the following main components:

- recuperative ventilation unit with air circulation of DUPLEX R5 series
- heat pumps and storage reservoirs
- the complete measurement and control system with the option to control other parts of the system (e.g. zone flaps, ground heat exchangers, etc.), including connection via internet
- the integrated system of ATREA air ducts and fittings suitable for all the required versions

Use not only in low-energy and passive houses

Owing to the circulation circuit possibilities, utilisation consists in the wide scope of applications, in which DUPLEX R5 ensures balanced ventilation with heat recovery.

- Balanced ventilation and cooling – heating are ensured by the independent heating system, DUPLEX R5 connects the circulation circuit on request for distribution of gains from the fireplace or on request for cooling
- Warm-air heating, ventilation and cooling – the system with the DUPLEX R5 unit substitutes the heating system in rooms – thus it is the only HVAC system that meets a requirement for heating by means of air heating only. The customer selects an exchanger for the unit – low-temperature water exchanger (T) or electric exchanger (E).

Design of DUPLEX R5 ventilation and heating system

The company ATREA prepared the detailed basis of project for designing of ventilation systems providing designers, together with catalogues of elements and the specialised design software, with all the necessary information for proper designing and dimensioning of ventilation and warm-air heating.

Based on the long-term measurements and experience with the implementation of the ventilation systems in the residential buildings, the ATREA company recommends dimensioning of the ventilation performance according to ČSN EN 15251 - Class 2 - see the marked part of the table below.

Ventilation system advantages

- guarantee of necessary in terms of hygiene continuous air changes with the possibility of occasional increasing (e.g. by an external signal from WC, bathroom, kitchen or other inputs according to the specific immediate requirements of users)
- saving up to 90 % of costs for the ventilation due to the high efficiency heat recovery exchangers
- exclusion of mould growth
- exclusion of thermal discomfort caused by the air supply with minimum temperature difference (again because of the high efficiency heat recovery)
- use of all internal and external heat gains from the apartment space for recuperative preheating of the ventilation air
- perfectly filtered air supply (through G4 or F7 filters) significantly limits the development of allergic and respiratory diseases of residents
- when setting the max. unit performance (through the by-pass), cooling in summer period is possible, mainly by night filtered air supply
- integrated modular system allows simple, also unassisted, installation

Legislative requirements

The DUPLEX R5 units carry energy labels in accordance with EU Regulation no. 1253/2014 and 1254/2014.

Ventilation performance

Standard – regulation		Ventilation intensity in unoccupied rooms (h ⁻¹)	Ventilation intensity (h ⁻¹)	Volume per person (m ³ /h)	Kitchens (m ³ /h)	Bathrooms (m ³ /h)	Toilets (m ³ /h)
CSN EN 15665 – Z1	Minimum value	0,3	0,3	15	100	50	25
	Recommended value		0,5	25	150	90	50
CSN EN 15251	1st Class	0,1 – 0,2	0,7	36	100	72	50
	2nd Class		0,6	25	72	54	36
	3rd Class		0,5	15	50	36	25
CSN 73 0540 – 2		0,1	0,3–0,6	15–25	References to other regulations		

More documentation for designing a ventilation system

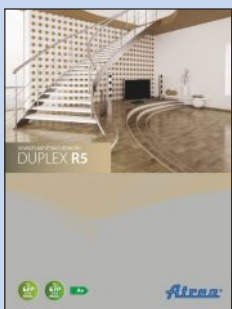

Marketing catalogue R5



Catalogue of components



www.atrea.eu

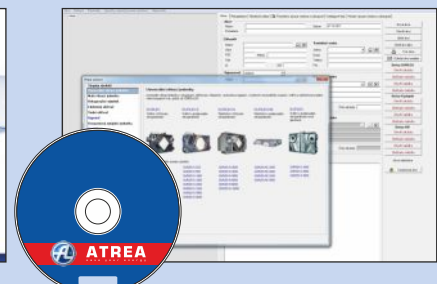

CD

Selection software

HEAT RECOVERY – WHAT IS IT ?

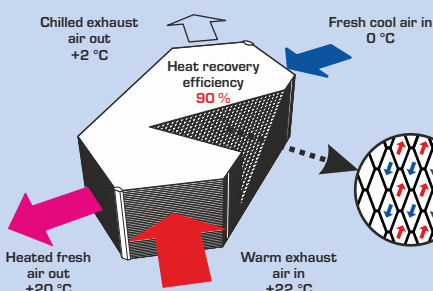

Heat recovery principle

Heat transfer occurs through the separating walls of a heat exchanger – in winter warmer exhaust air preheats colder supply air. The same principle is applied also in summer for cool recovery.

In winter time humidity condensates in exhaust air. This condensate increases heat recovery efficiency through improved heat transfer and is continuously drained into a sewer system.

Significance of heat recovery

An energy-optimised heat recovery exchanger reaches a highly economical ratio between power consumption (to run fans), air performance and heat recovery.

The fan input vs. heat recovery gain ratio during ventilation reaches an energy efficiency of 17–25, i.e. from 1 W of power used to run a DUPLEX R5 up to 25 W is recovered from exhaust air.

Effective ratio 1 : 25

DESCRIPTION OF DUPLEX R5 UNITS

Purpose

The new 5th generation of recuperative DUPLEX units is available in two basic versions, as **DUPLEX RB5** in the ceiling design and as **DUPLEX RA5, RK5** in the upright design.

The units are intended for comfort ventilation and warm-air heating of all types of residential and public buildings, are particularly suitable for low-energy and passive houses and for flats in block of flats.

Basic description

The unit housing, made with mineral insulation with the thickness of 30 mm ($U = 0,81 \text{ Wm}^{-2}\text{K}^{-1}$), with suppression of thermal bridges and excellent sound deadening, is fitted with a swirling counterflow plastic heat recovery exchanger (efficiency up to 91 %), two ventilators of free impeller type with the electronic EC control, including control of a constant air flow, G4 filters of supply air as well as exhaust air before entering the recovery heat exchanger, an automatic by-pass flap, a control module and a connection terminal block. Condensate outlets are as standard prepared for the cooling version as well. Connection ports are circular, used for connecting flexible or fixed piping with suppression of thermal bridges. Access to the unit is possible through the openable hinged door via locking latches.

Units advantages

- fans built-in as standard with an EC type free impeller are characterized by very low power consumption and excellent speed regulation

- higher outputs of the units enable occasional intensive air exhaust or summer ventilation
- recovery efficiency up to 91 % due to the new-generation counterflow recuperation exchangers
- excellent thermal insulation parameters of the unit housing with suppression of thermal bridges
- built-in by-pass is a standard part of the unit and needs no additional space; in addition, due to its construction, it ensures 100% by-pass in the by-pass mode without mutual thermal transfer
- standard control meets all the requirements of control, enabling the wide scope of connection of sensors and other inputs, control of shutting and zone flaps for distribution, control of heaters or the heating system of the house, etc., and furthermore, as standard, **includes a built-in web-server to enable control via internet**
- universal use from balanced ventilation, ventilation with circulation, circulation with heating and cooling
- option of a built-in type heater: low-temperature water exchanger (T) or electric exchanger (E).
- exchanger for direct (CHF) or water (CHW) cooling, option of two sizes - three-row and five-row

CONDENSATE OUTLET

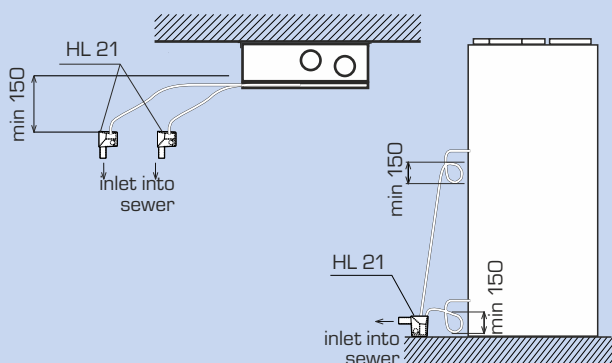

During the recovery, the heat recovery, moisture condensation occurs during the exhaust air cooling. Water condenses on the walls of the heat recovery exchanger; thereby further increasing the heat recovery efficiency. In the direction of the exhaust air flow, condensate flows from the recovery heat exchanger and is discharged from the DUPLEX unit into the sewer system. For the proper function and discharge, it is necessary to separate the unit and the sewer by a siphon with the sufficient height - min. 150 mm height is recommended. Small condensate discharge pumps can be used as well.

R5 RECOVERY EFFICIENCY

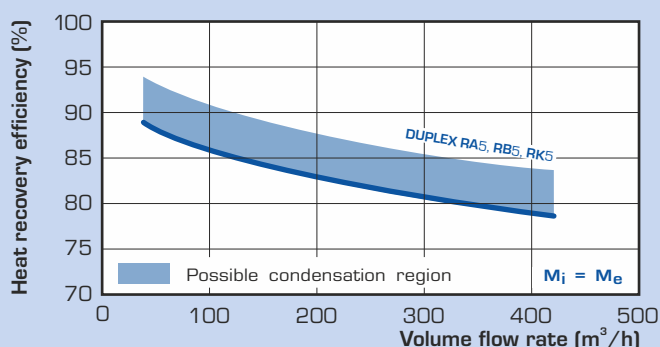

TECHNICAL DATA OF ERP DUPLEX R5

DUPLEX		RA5	RK5	RB5	
specific energy class	-	A ¹⁾	A ¹⁾	A ¹⁾	
specific energy consumption	SEC-W	kWh/m ² .a	-16,92	-16,74	-16,55
	SEC-A	kWh/m ² .a	-40,82	-40,64	-40,57
	SEC-C	kWh/m ² .a	-77,96	-77,77	-77,90
maximum flow ²⁾		m ³ h	420	445	430
sound power level ³⁾	L _{WA}	dB	41	42	44

¹⁾ All types of the regulation built-in in the unit standardly include a minimum of two inputs for connecting electrical signals arising as a result of human manipulation with lighting, or for connecting other devices that automatically regulate the unit output. These inputs must always be connected, or other types of sensors (e.g. CO₂, VOC, rH and the like) must be connected instead.

²⁾ The maximum flow rate is set at the pressure disposition of 100 Pa

³⁾ The stated value refers to the reference flow rate i.e. 70 % of the maximum flow rate, and to the pressure disposition of 50 Pa

DIMENSIONS AND DESIGN

R5 DIMENSIONS AND DESIGN

DUPLEX RA5

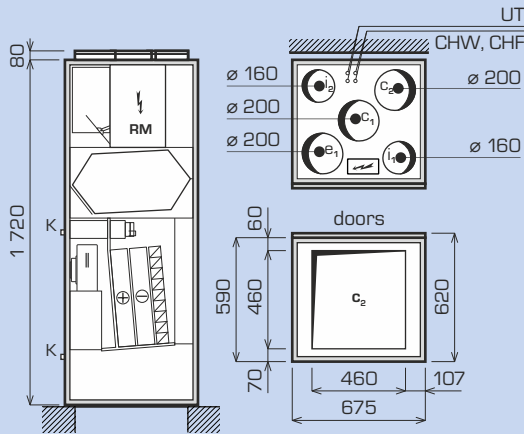

Version

10/0

11/0

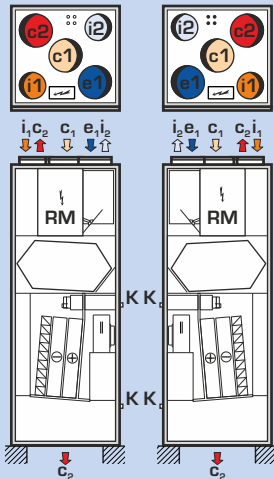

Port configuration

10/1

10/2

10/3

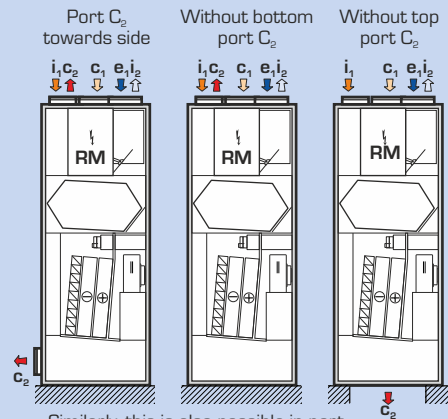

Similarly, this is also possible in port configurations 11/1, 11/2, 11/3.

DUPLEX RK5

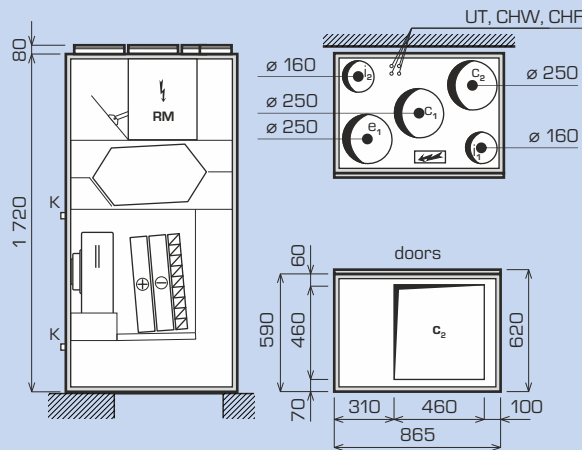

10/0

11/0

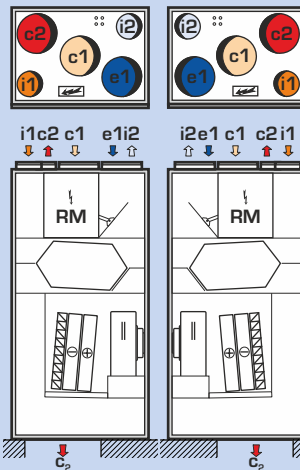

10/1

10/2

10/3

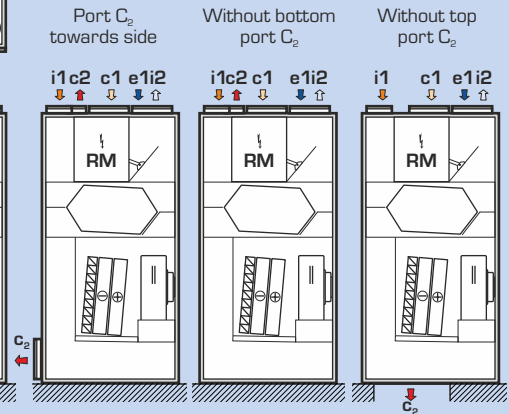

Similarly, this is also possible in port configurations 11/1, 11/2, 11/3.

DUPLEX RB5

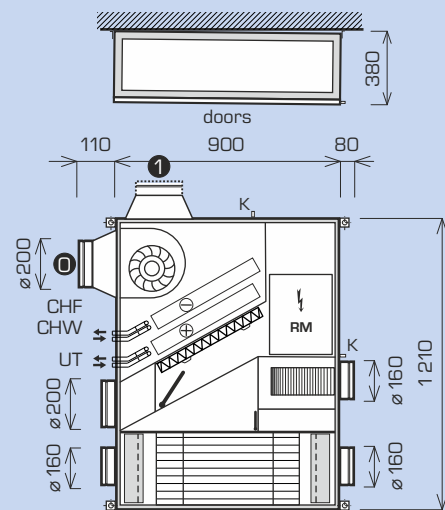

30/0

31/0

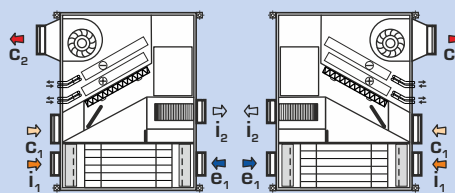

30/1

31/1

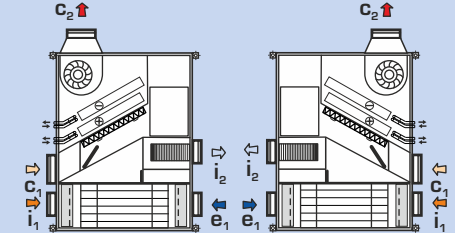

- ⊙ port position in design x/0
- ① port position in design x/1 - this is performed on site by turning the fan to a prepared position.

Note: Top view - plan view

Legend

e ₁	fresh air inlet	UT	connection of heating water (T) or electricity (E)
c ₁	circulation air inlet	CHF	connection of mechanical cooling
c ₂	outlet of circulation air and fresh air	CHW	connection of water cooling
i ₁	exhaust air inlet	RM	digital control module RD5
i ₂	exhaust air outlet		
K	condensate outlet		

WEIGHT AND CONNECTION

DUPLEX		RA5	RB5	RK5
diameter of connection ports	mm	∅ 160 / ∅ 200	∅ 160 / ∅ 200	∅ 160 / ∅ 250
weight [according to equipment]	kg	115 - 125	87 - 97	125 - 135
condensate outlet	mm	2x ∅ 16		
UT, CHW connecting pipes	mm	20 / 20		
CHF connecting pipes	mm	12,7 / 6,35		

CIRCULATION AIR FAN

DUPLEX RA5

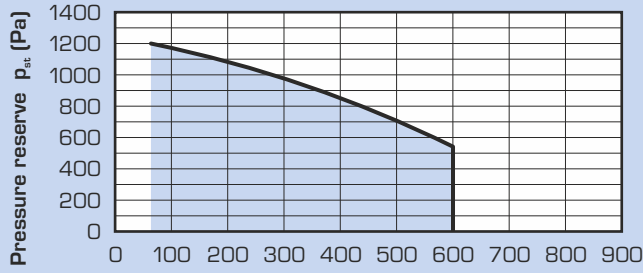

DUPLEX RB5

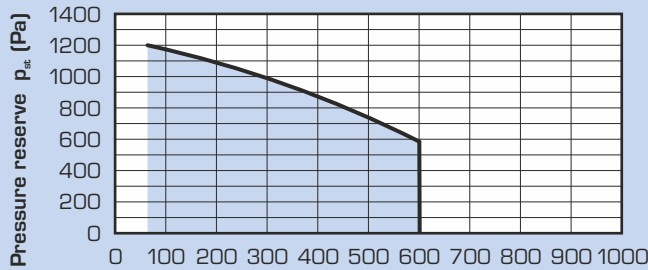

DUPLEX RK5

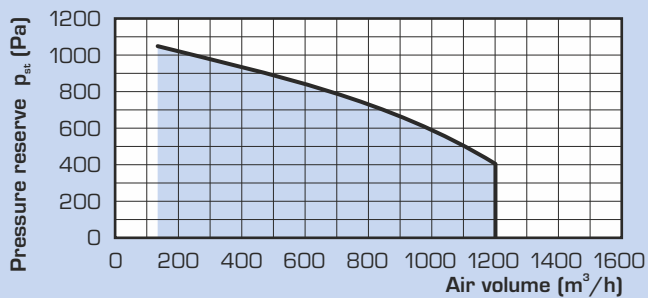

EXHAUST AIR FAN

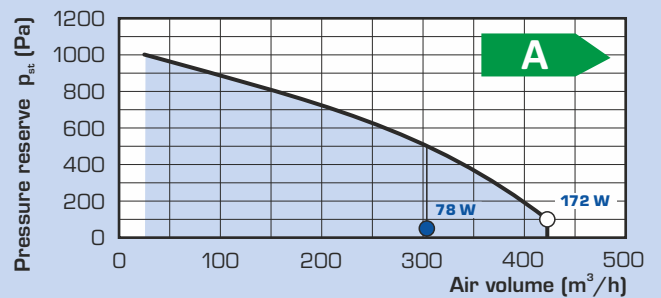
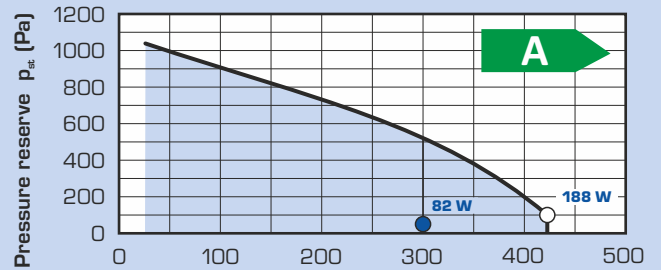
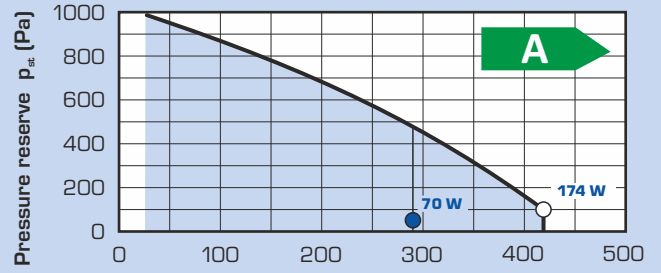

Legend:

- Q_{ref} reference flow **
- Q_{max} maximum flow **

- * max. pressure reserve curve is indicated
- ** electrical power consumption of the entire unit (both fans including the regulation) is indicated at the same flow in the ventilation mode

DIRECT EVAPORATOR (CHF.3)

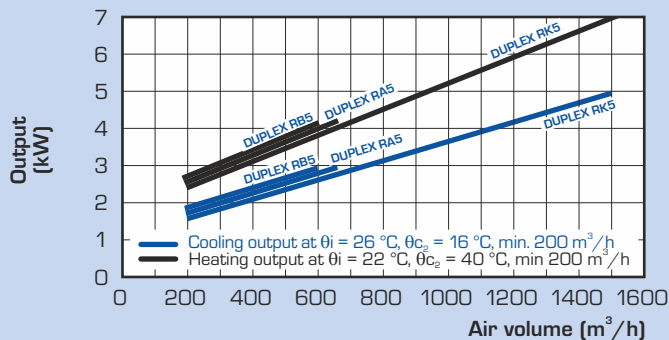

3-ROW WATER COOLER (CHW.3)

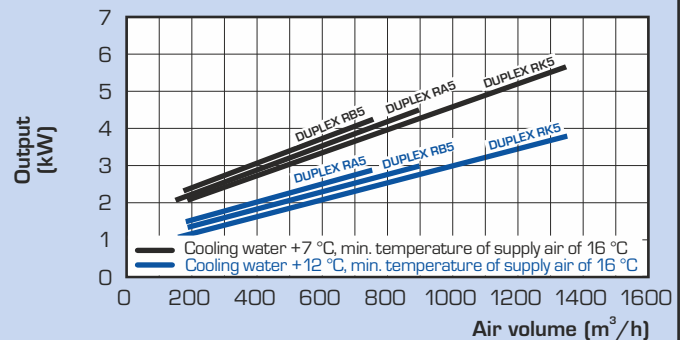

HOT-WATER HEATER (T.3)

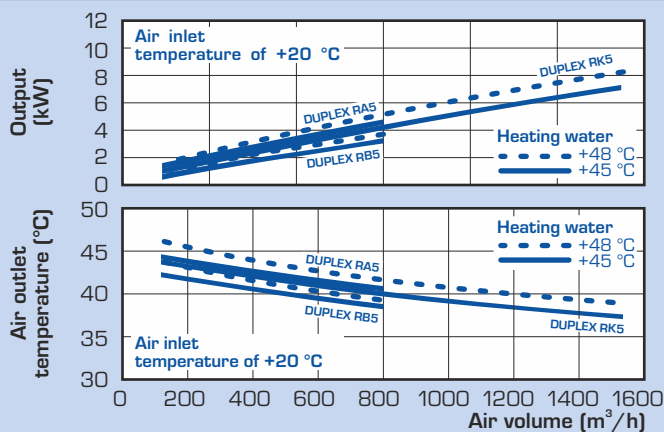

5-ROW WATER COOLER (CHW.5)

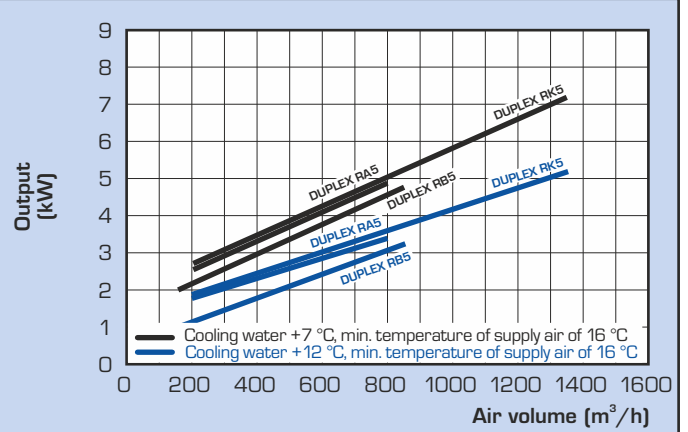

CONTROL SYSTEM

RD5 DIGITAL CONTROL SYSTEM

Basic description

Digital control module type RD5 is the most advanced method for the unit control. It provides all the basic functions and also includes a number of other inputs and outputs for connecting with optional sensors (e.g. CO₂ sensors, relative humidity sensors), signals from the rooms (WC, bathroom, kitchen), the heating systems including the shut-off valves or the shut-off butterfly valves in the distribution system. In addition, it includes the **web-server** and the **Internet access**.

The units with the digital module can be controlled:

- Via the CP Touch controller with a touch display,
- Via the intelligent built-in web-server – allows controlling and set-up via a web application, and is possible also for the options a),
- Via a foreign control system via a standard interface Modbus TCP.

Functions

The control module provides all the basic functions of the unit:

- programming of the various outputs of ventilation, heating and cooling during the day and the week
- continuous output control of both fans with the constant flow function
- automatic control of the by-pass butterfly valve (supply air by-pass) according to the outside air temperature
- control of various heat sources on request for afterheating or heating of rooms with separate control of temperature in bathrooms
- control of cold sources – ground exchangers and heat pumps on request for cooling, with protection against going below minimum temperature of supply air
- the recovery exchanger frost protection
- switching to the selected output when closing through the external signal (e.g. from WC, bathroom, kitchen) with optional start and run-down
- control of the shut-off butterfly valve at the inlet and the exhaust, and also two zone ventilation butterfly valves and one exhaust butterfly valve from the kitchen (the butterfly valves are not part of the unit) – 24 V DC

- continuous control of circulation (mixing) flap
- optional automatic operation controlled by sensors – CO₂ concentration, relative humidity or VOC (optional accessory) – 0–10 V input or switching contacts
- according to the settings, the unit allows periodic ventilation mode – the unit is at rest and switches ventilation at set intervals
- automatic setting of the ventilation length depending on the number of persons and the building airtightness – at the periodic ventilation or when running the intermittent ventilation

CP Touch controller: The modern, wall mounted CP Touch controller is intended for setting the basic ventilation and circulation modes and displaying the status of the ventilation unit including the indication of fault conditions. It allows the user access to common functions or programming of the operating modes that can be operated in the manual mode or the automatic mode according to the weekly program settings. The controller also allows setting a temporary party / holiday mode. Part of the controller is an integrated room thermostat with a weekly heating/cooling program, which can also control the simple heating system by using the functions of the control module. All values can be set on the well structured graphical touch screen.

CP Touch



Required connections ← Optional connections →

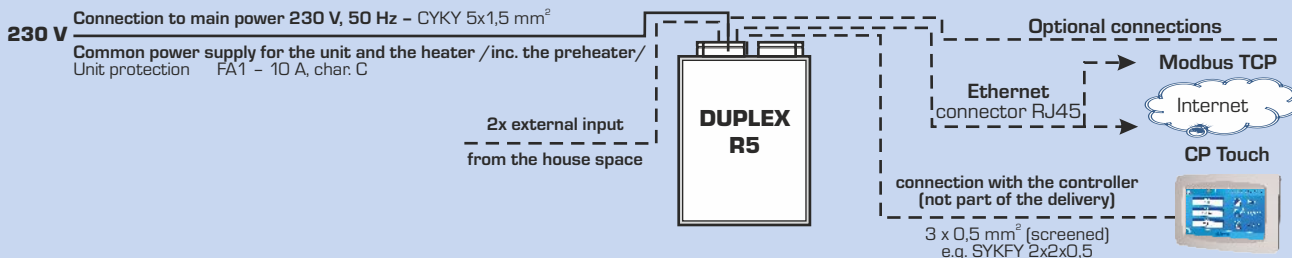

CONTROL AND ENERGY SYSTEMS FOR HEATING AND HOT SERVICE WATER HEATING

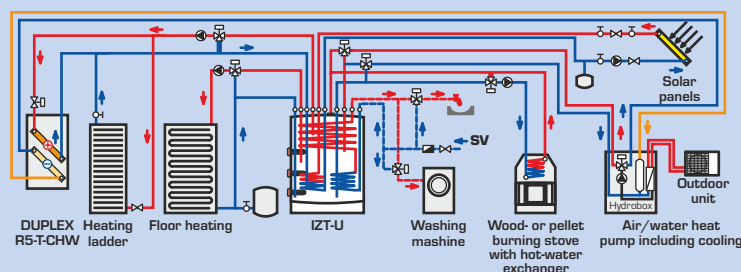

DUPLEX RB5-T-CHW

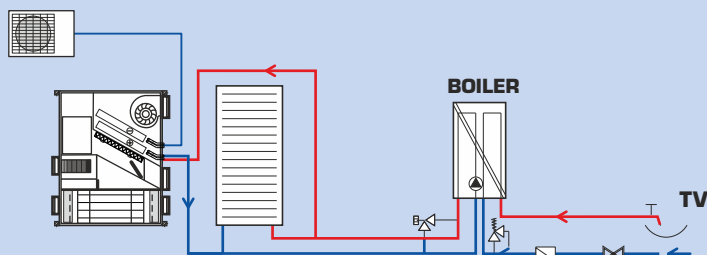

DUPLEX RB5-T-CHF

The integrated heat accumulator IZT (e.g. IZT-U-TTS 650) for combined preparation of hot water (HW) and central heating (CH) by means of electric coils with solar support or connection to the heat pump (HP).

The double exchanger is intended for flow-through heating of hot water, excluding occurrence of Legionella germ and corrosive sludge, presence of which is common in storage boilers.

The bottom exchanger is connected to the solar system. The heat accumulator IZT can also be connected to biomass boilers or heat pumps, where the condensing unit provides heating or cooling, IZT serves as a bivalent source. It is not necessary to realise all the described sources at the same time.

An electric or a condensing boiler burning natural gas, with a built-in hot water heater or a separate hot water reservoir. Gas boilers with the built-in output modulation depending on water temperature, providing a continuous change of the boiler output in the range from 15 to 100%. The prospective outdoor condensing unit with the option of reverse operation makes it possible, in connection with the basic and the additional control DUPLEX RB5, to cool interior during summer season and heat interior during transition periods (spring, autumn) – systems of air-air heat pumps.

DUPLEX R5 UNIT OPERATION MODES

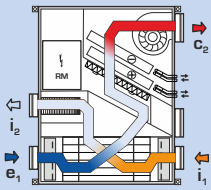

1

Balanced ventilation mode

all-year period
 $n_v = 0,15 - 0,5 / h^{-1}$ $n_c = 0 / h^{-1}$
 Balanced ventilation with adjustable output from 75 to 440 m³/h, with recovery or via the by-pass. It is intended for ventilation and afterheating (without circulation) in the transition period.
 Both fans in operation, the mixing flap closed.

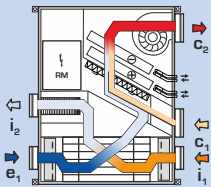
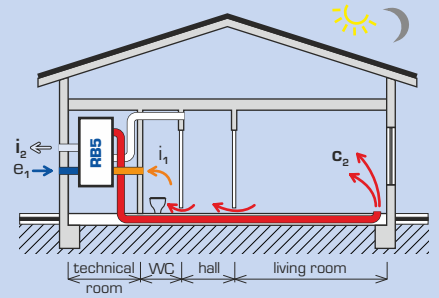

2

Circulation heating and ventilation mode

Heating period
 $n_v = 0,15 - 0,5 / h^{-1}$ $n_c = 0,5 - 1,5 / h^{-1}$
 Warm-air circulation heating and balanced ventilation with waste heat recovery with circulation output up to 600 (600, 1200 depending on R5 type) m³/h (at 150 Pa) and ventilation output up to 420 / 430 / 445 m³/h (at 150 Pa)
 Both fans in operation, the mixing flap mixes outdoor air and circulating air:

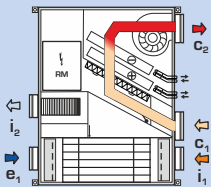
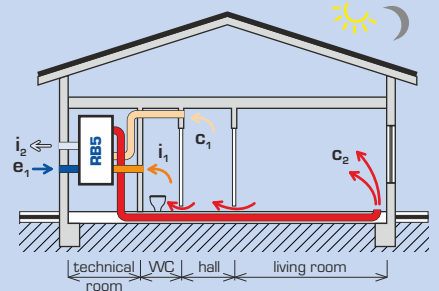

3

Circulation heating mode with intermittent ventilation

Heating period
 $n_v = 0$ $n_c = 0,5 - 1,5 / h^{-1}$
 The basic recommended operation mode of circulation heating. When persons are present, an impulse from the WC and the bathroom occasionally switches the exhaust fan with an adjustable run-down, an impulse from the kitchen switches to the mode No. 1 without run-down. If appropriate, ventilation is periodically switched at a set interval. All of them with recovery. When mechanical cooling is realised, this mode is also used for heating by means of the air-conditioning unit in the transition period (spring, autumn).

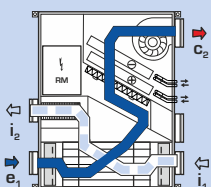
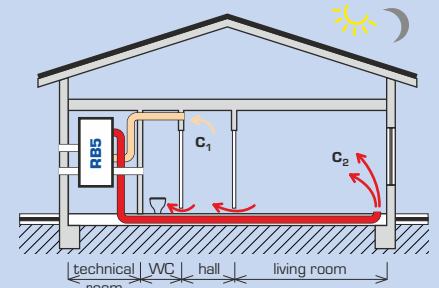

4

Overpressure ventilation mode

Summer season
 $n_v = 0,5 - 2,0 / h^{-1}$ $n_c = 0 / h^{-1}$
 The intensive summer overpressure ventilation of residential premises by fully supplying outdoor air, prospectively from the ground heat exchanger. It can also be used for night precooling.
 Air outlet through a slightly open door.
 The effluent air fan is activated by an impulse, the mixing flap in the position „2“, the by-pass flap is opened.

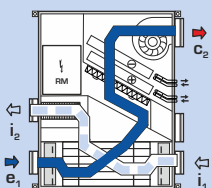
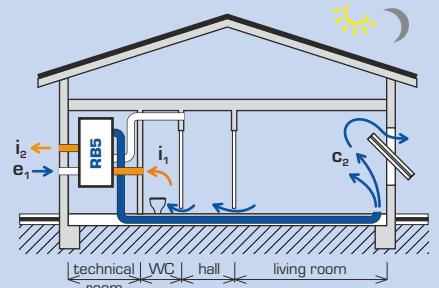

5

Circulation cooling mode with ground heat exchanger (ZVT-c; ZVT-s)

Summer season
 $n_v = 0 / h^{-1}$ $n_c = 0,5 - 1,5 / h^{-1}$
 The intensive summer circulation cooling of residential premises by interior air, circulating through the ground heat exchanger. The effluent air fan is activated by an impulse, the mixing flap in the position „2“, the by-pass flap is opened.
 This can only be in connection with realisation of the circulation ground exchanger of an air or an anti-freezing liquid type.

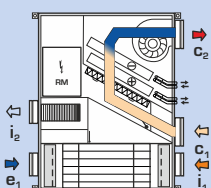
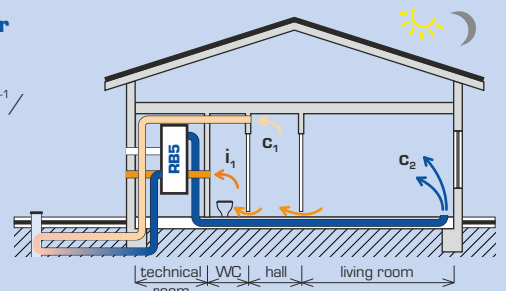

5a

Mechanical circulation cooling mode

Summer season
 $n_v = 0 / h^{-1}$ $n_c = 0,5 - 1,5 / h^{-1}$
 The intensive circulation cooling of residential premises in connection with the outdoor condensing unit („mechanical cooling“). When persons are present, an impulse from the bathroom and the WC occasionally switches the ventilation fan with an adjustable run-down. An impulse from the kitchen switches to the mode No. 1 without run-down. In this case, cooling is not enabled. If appropriate, ventilation is periodically switched at a set interval.

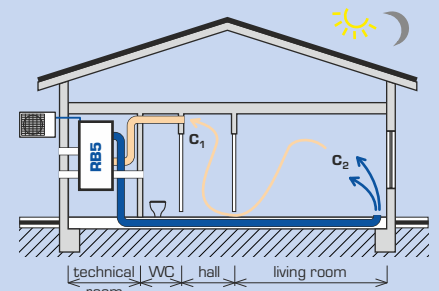

c_1 inlet of circulation air from rooms to the unit
 c_2 outlet of heating air, cooling air and fresh air from the unit to rooms

e_1 inlet of fresh outdoor air
 i_1 inlet of effluent air from sanitary facilities to the unit
 i_2 outlet of effluent air from the unit

ATREA MODULAR HVAC SYSTEM

DUPLEX R5 UNITS

	DUPLEX RA5 800 / 420	Ord. No. A170421
	DUPLEX RB5 800 / 430	Ord. No. A170431
	DUPLEX RK5 1400 / 440	Ord. No. A170441

FILTERS

	FT RB4 G4 – circulation	Ord. No. A170922
	FT RB4 F7 – circulation	Ord. No. A170923
	FTU RB4 – circulation carbon	Ord. No. A170929
	FT RB4 G4 – exhaust	Ord. No. A170926
	FT RA3 G4 – circulation (RA3, RK3, RA4, RK4, RA5, RK5)	Ord. No. A170912
	FT RA3 F7 – circulation (RA3, RK3, RA4, RK4, RA5, RK5)	Ord. No. A170913
	FTU RA3 – circulation carbon (RA3, RK3, RA4, RK4, RA5, RK5)	Ord. No. A170928
	FT RA4 G4 – exhaust (RA4, RK4, RA5, RK5)	Ord. No. A170920

Spare filter fabrics are delivered in a 5 pc pack.

	FK RB4 G4 – circulation	Ord. No. A170924
	FK RB4 F7 – circulation	Ord. No. A170925
	FK RB4 G4 – exhaust	Ord. No. A170927
	FK RA3 G4 – circulation (RA3, RK3, RA4, RK4, RA5, RK5)	Ord. No. A170914
	FK RA3 F7 – circulation (RA3, RK3, RA4, RK4, RA5, RK5)	Ord. No. A170915
	FK RA4 G4 – exhaust (RA4, RK4, RA5, RK5)	Ord. No. A170921

Spare filter cassettes are delivered in a single-piece package.

OPTIONAL ACCESSORIES - WATER HEATER

	Modification T - water heater RA5	Ord. No. A170422
	Modification T - water heater RB5	Ord. No. A170432
	Modification T - water heater RK5	Ord. No. A170442



OPTIONAL ACCESSORIES - WATER COOLER

	Modification CHW – water cooling RA5, 3-row	Ord. No. A170424
	Modification CHW – water cooling RA5, 5-row	Ord. No. A170425
	Modification CHW – water cooling RB5, 3-row	Ord. No. A170434
	Modification CHW – water cooling RB5, 5-row	Ord. No. A170437
	Modification CHW – water cooling RK5, 3-row	Ord. No. A170444
	Modification CHW – water cooling RK5, 5-row	Ord. No. A170445







OPTIONAL ACCESSORIES - DIRECT COOLER

	Modification CHF – mechanical cooling RA5	Ord. No. A170426
	Modification CHF – mechanical cooling RB5	Ord. No. A170438
	Modification CHF – mechanical cooling RK5	Ord. No. A170446

CONTROLLERS

	CP Touch controller – touchscreen – 4 color versions (white, ivory, grey, anthracite)	Ord. No. A170130 Ord. No. A170131 Ord. No. A170132 Ord. No. A170133
	ADS 100 ABB	Ord. No. A170258



OPTIONAL ACCESSORIES - 0-10 V DIGITAL INPUT

	ADS RH 24 room relative humidity sensor	Ord. No. A142318
	ADS SMOKE 24 room cigarette smoke and air quality sensor	Ord. No. A142311
	ADS VOC 24 room air quality sensor	Ord. No. A142331
	ADS CO₂ 24 room sensor controlling the ventilation performance based on the current CO ₂ value	Ord. No. A142319
	ADS CO₂ D channel sensor controlling the ventilation performance based on the current CO ₂ value	Ord. No. A142330
	ADS RH D channel relative humidity sensor	Ord. No. A142332

OPTIONAL ACCESSORIES - CONTACT INPUT

	HYG 6001 room hygrostat – relative humidity sensor	Ord. No. A142303
---	--	------------------

OPTIONAL ACCESSORIES - MECHANICAL COOLING

	ATREA FG09 (RB5) outdoor condensing unit	Ord. No. A400010
	ATREA FG14 (RA5, RK5) outdoor condensing unit	Ord. No. A400015
	ATREA FG18 (RK5) outdoor condensing unit	Ord. No. A400019
	DMCH – ATW (FG09) additional control module	Ord. No. A170511
	DMCH – ATW (FG14) additional control module	Ord. No. A170512
	DMCH – ATW (FG18) additional control module	Ord. No. A170513

OPTIONAL ACCESSORIES - ELECTRIC HEATER

	Modification E – electric heater RA5	Ord. No. A170423
	Modification E – electric heater RB5	Ord. No. A170433
	Modification E – electric heater RK5	Ord. No. A170443

OPTIONAL ACCESSORIES - ZONE FLAP

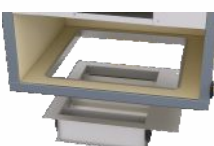
	Zone flap including servo drive for RA5 / RK5 it can only be used with distribution chamber R111011 and R111010	Ord. No. A170427
--	---	------------------