

DUPLEX Easy2

Compact ventilation units

with heat recovery

Intended use

Compact ventilation units with heat recovery are designed for central equal-pressure ventilation of houses or apartments.

Units description

The units can be installed in an under-ceiling or wall-mounted position. The heart of the unit consists of a counterflow high efficiency plate heat recovery exchanger. Airflow is provided by high efficiency EBM radial fans. The unit includes filters for supply and extract air filtration.

Units advantages

- Very low noise level to surroundings
- Compliant with energy class **A+/A**
- Very low height
- Connection ports without thermal bridges
- Installation possible for ceiling suspended or wall mounted position

Units comply with:

- EU Commission Regulation 1253/2014 (Ecodesign) valid from 2018
- Energy class of units according to 1253/2014 **A+/A** (for average climate)



A+



OPERATING MODES

DUPLEX Easy2

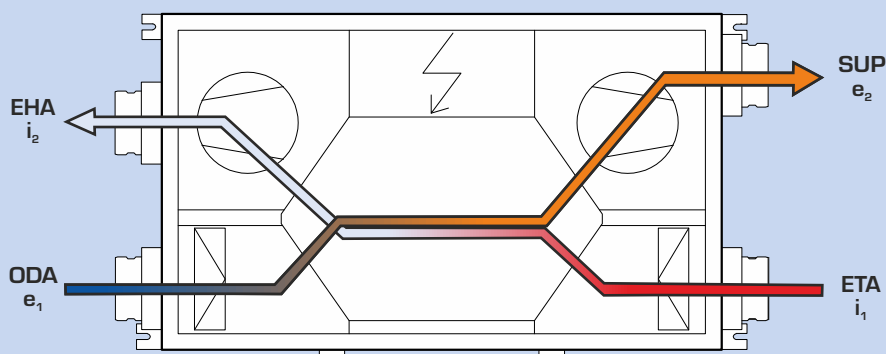

Key:

- ➔ ODA (e₁) fresh outdoor air inlet
- ➔ SUP (e₂) fresh heated air outlet
- ➔ ETA (i₁) exhaust air inlet
- ➔ EHA (i₂) exhaust air outlet

equal pressure ventilation
with heat recovery

SELECTION SOFTWARE



For the detailed design of DUPLEX series units, accessories and control systems we recommend using our selection software. You can find it on our website at www.atrea.eu.

Altea[®]

VENTILATION UNITS WITH HEAT RECOVERY

ATREA s.r.o., Čs. armády 32
466 05 Jablonec n. Nisou
Česká republika



Tel.: +420 483 368 133

Fax: +420 483 368 112

E-mail: atrea@atrea.eu

www.atrea.eu

DUPLEX Easy2 UNITS

DUPLEX Easy2 GENERAL DESCRIPTION

The units are used in systems for comfortable ventilation of family houses, apartments, offices or smaller commercial premises.

The units can be installed at ceiling suspended or wall-mounted position. The casing of the unit is designed as a sandwich construction of the composition of an external metal sheet (surface treatment aluzinc) - thermal and acoustic insulation (mineral wool thickness 30 mm, reaction to fire class A2/A1) internal metal sheet (surface treatment zinc coating).

The units are equipped with two radial fans, a plate counter-flow plastic heat recovery heat exchanger, air filtration at the supply and extract air with Coarse 90% (G4) or ePM1 55% (F7) filtration class and a control module with terminal block.

The unit has a ready connection for condensate drainage, connection ports with thermal bridge suppression, access for filters change, service access to the heat recovery exchanger via a fully opening door.

Delivery is possible with several types of control modules:

- The basic controls **.CP** type allows full control by touchpad, power setting according to the calendar and control according to the air quality sensor (usually CO₂).
- The advanced controls **.aM** type allows control via touch controls, mobile app or PC. It allows connection of a wide range of accessories such as zone dampers, air quality sensors, heaters and more...

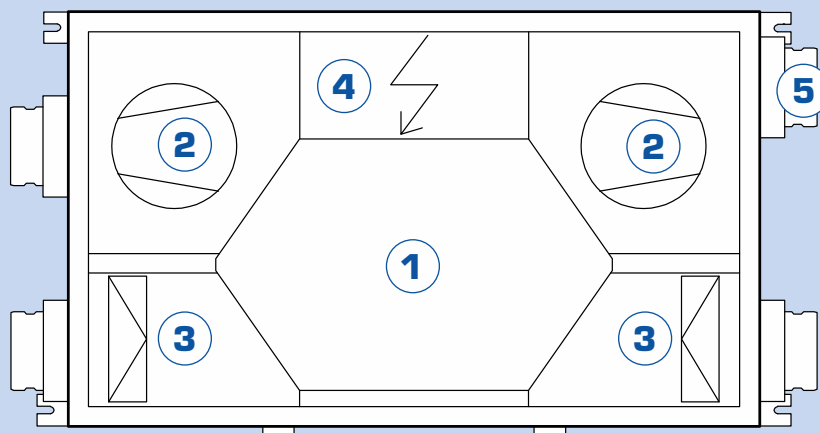

Key:

- 1 Counter-flow heat exchanger
- 2 Supply or extract air fan
(depending on specific orientation)
- 3 Fresh or exhaust air filter
(depending on specific orientation)
- 4 Control module with connection terminal block
- 5 Connection ports without thermal bridges

PERFORMANCE PARAMETERS DUPLEX Easy2

DUPLEX 200 Easy2

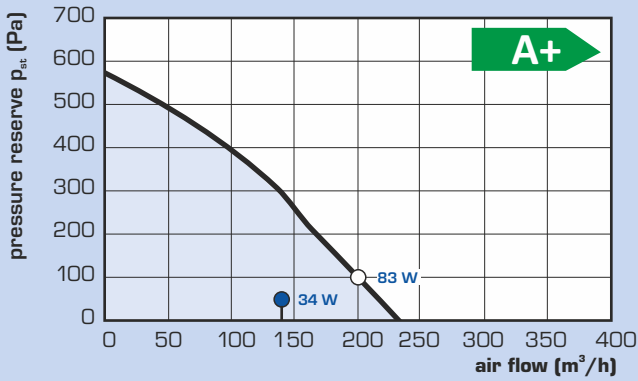

DUPLEX 300 Easy2

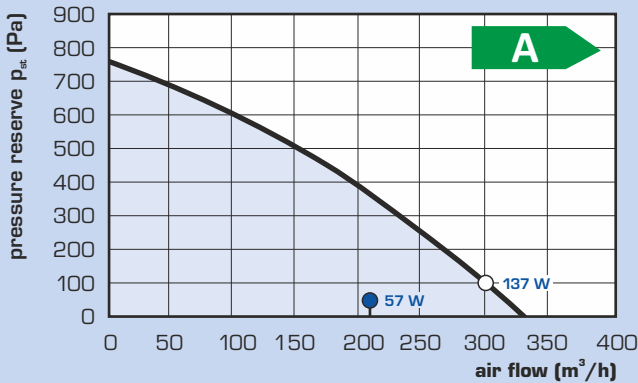

DUPLEX 500 Easy2

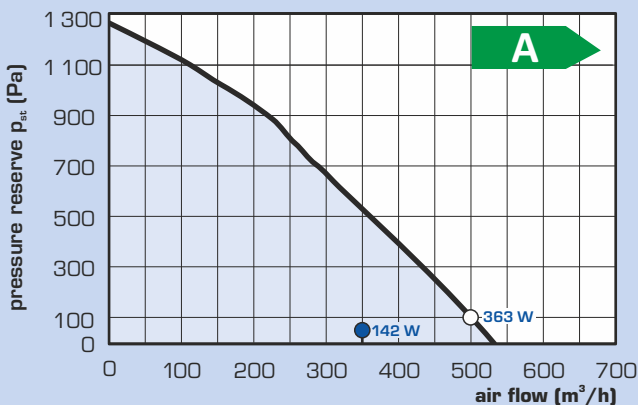

Key:

● Pressure reserve with ISO Coarse 90% filter (G4)*
 ○ Q_{ref} reference flow (70% Q_{max}, 50 Pa)
 ○ Q_{max} maximum flow (100Pa)

* max. pressure reserve curve is listed
 * the electrical input of the whole unit (both fans including controls) is listed

HEAT RECOVERY EFFICIENCY DUPLEX Easy2

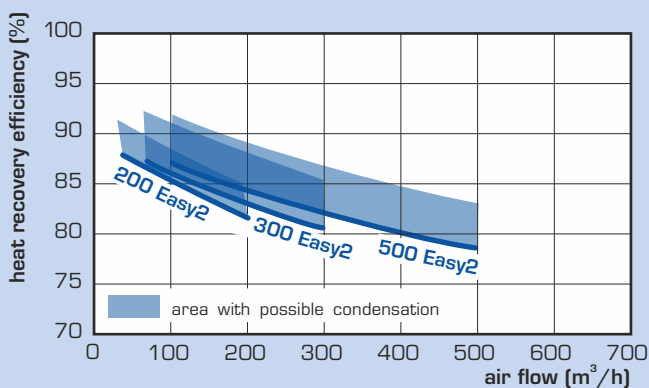

*valid for balanced mass air flow at supply and exhaust

TECHNICAL DATA DUPLEX Easy2

DUPLEX Easy2	200	300	500	
energy class ¹⁾	-	A+	A	A
maximum flow rate ²⁾	m³/h	200	300	500
sound power to ambient ³⁾	dB (A)	38	43	49
max. heat recovery efficiency	%	91	92	92
diameter of the connection ports	mm	ø 125	ø 160	ø 200
weight	kg	49	50	61
ower supply, fuses	-	230 V / 50 Hz, 16A char: C		
supply air filtration class	-	ISO Coarse 90% (G4) alternatively ISO ePM1 55% (F7)		
condensate drainage	mm	ø 16 (2 m hose included) + 2 × G5/4" × ø32/40 (0.7 m hose included)		

¹⁾ All types of controls built into the unit normally include a minimum of two inputs to connect the electrical signals that result from human manipulation of the light or other devices that automatically control the unit's output. These inputs must always be connected, or other types of sensors (e.g. CO₂, VOC, rH, etc.) must be connected instead.

²⁾ The maximum flow rate is set at a pressure loss of 100 Pa

³⁾ The listed value refers to the reference flow rate i.e. 70% of the maximum flow rate and a pressure loss of 50 Pa

DUPLEX Easy2 DIMENSIONAL DIAGRAM

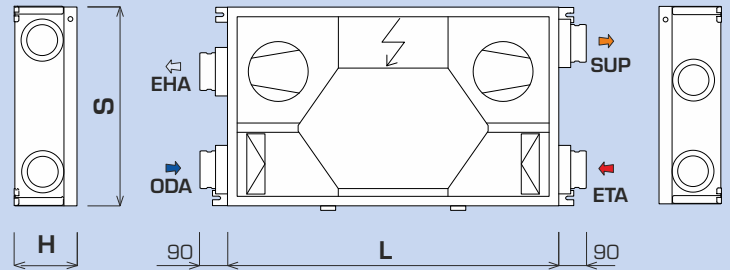

DUPLEX Easy2	200	300	500	
height H	mm	220	245	290
width S	mm	660	660	665
Length (without connection port) L	mm	1 100	1 100	1 200

For detailed information and for 2D or 3D blocks in format DXF / IFC / RFA please use our selection software.

MOUNTING POSITIONS DUPLEX Easy2

UNDER-CEILING POSITION

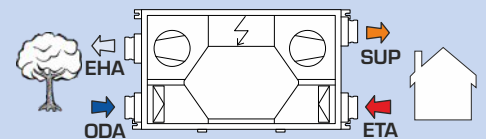

WALL-MOUNTED POSITION

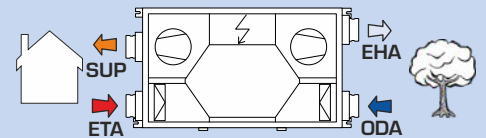
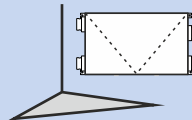

The DUPLEX Easy2 units are supplied in universal design, i.e. the choice between "right" and "left" orientation, according to the picture above, is made for the .aMotion type of control by changing a parameter in the control system, for the .CP type by reconnecting the fans and relocating the thermostat for frost protection of the heat exchanger.

ACOUSTIC PARAMETERS DUPLEX Easy2

Sound power levels for specific unit of DUPLEX Easy2 and the selected operation point to be found in the ATREA selection software.

KEY

- ➡ ODA (e₁) fresh outdoor air intake
- ➡ SUP (e₂) fresh heated air outlet
- ➡ ETA (i₁) extract air inlet
- ➡ EHA (i₂) exhaust air outlet

INSTALLATION VARIANTS OF DUPLEX EASY2 UNITS



DUPLEX Easy2 CONDENSATE DRAINAGE

WALL-MOUNTED POSITION

During the heat recovery process, when the exhaust air is cooled, an air humidity condenses and precipitates on the walls of the heat exchanger, further increasing the efficiency of the recovery. The condensate drains out of the heat exchanger in the direction of the exhaust air flow and is discharged from the DUPLEX unit to the sewer.

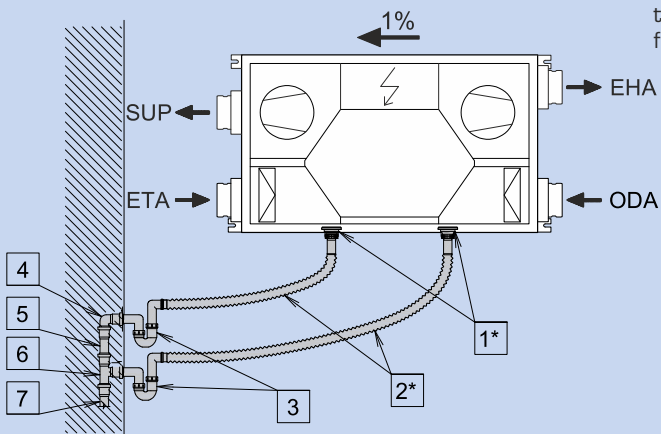

1*	2× outlet G5/4"
2*	2× flexi connection G5/4" × 32/40 (length 300 to 700 mm)
3	Odour stopper (e.g. AKS2)
4	Elbow (e.g. HT DN 40)
5	Pipe (e.g. HT DN 40)
6	Tap (e.g. HT DN 40/DN 40).
7	Connection to sewer DN 40

*included in the delivery of the unit

DUPLEX Easy2

DUPLEX Easy2 INSTALLATION

The new **DUPLEX Easy2** units provide a very flat design that allows the units to be installed in very low ceilings. The minimum height requirements for the installation at the ceiling are shown in the table below. A plasterboard hatch can be fitted under the unit. In bathrooms it is necessary to ensure that the ceiling, including the inspection door, is vapour proof.

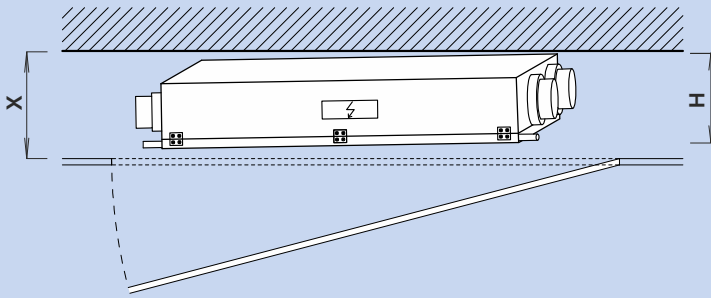

PLACEMENT OF THE UNIT IN THE SUSPENDED CEILING				
DUPLEX Easy2		200	300	500
unit height H	mm	220	245	290
min. ceiling height X	mm	245	270	315

DUPLEX Easy2 CONDENSATE DRAINAGE

RECOMMENDED

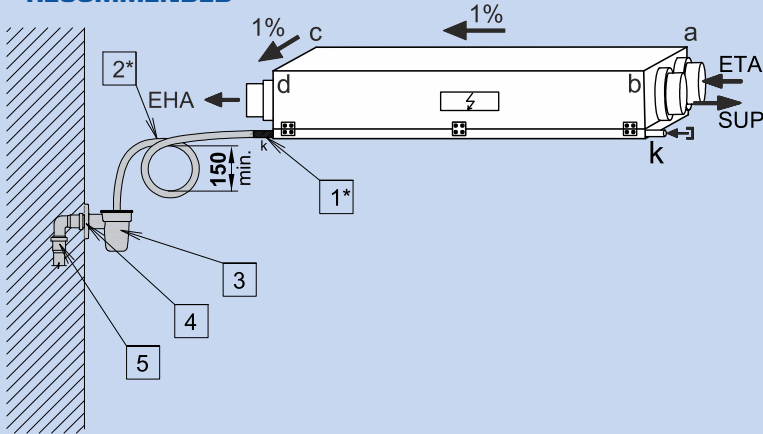

1*	Outlet sleeve 16 mm.
2*	Flexible hose, inner diameter 16 mm, length 2 m. To make a siphon loop of min. 150 mm.
3	Ball funnel (e.g. AKS1Z).
4	An elbow (e.g. HT DN 32).
5	Connection to sewer DN 32.

*included in the unit delivery

ALTERNATIVE

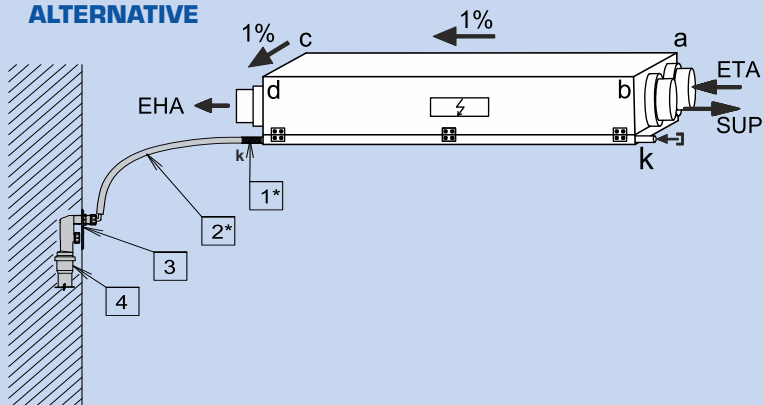

1*	Outlet sleeve 16 mm.
2*	Flexible hose, inner diameter 16 mm, length 2 m.
3	Odour stopper (e.g. AKS7).
4	Connection to sewer DN 40.

*included in the unit delivery

Unit incline and condensate drainage

For the condensate drainage function, the unit must be properly inclined towards the outlet i_0 (EHA). The following table shows the minimum slope. It is necessary to separate the unit and the sewer using a **siphon loop with a minimum height of 150 mm** or a "dry" ball siphon. Small condensate pumps may be used where the recommended connection to the sewer cannot be made.

INCLINE OF THE UNIT FOR CONDENSATE DRAIN				
DUPLEX Easy2		200	300	500
Distance from the corner of the unit to the horizontal ceiling structure (mm)	a	±0	±0	±0
	b	7	7	9
	c	11	11	12
	d	18	18	21

CONTROL SYSTEM – BASIC CP

CONTROL SYSTEMS – GENERAL DISTRIBUTION

type of the control system	power adjustment range	webservice	external inputs		control of external elements							
			delay +(timeout)	input 0-10 V	closing dampers	electric reheater / preheater	weekly program	water heater	water cooler	zone dampers 2x	kitchen damper	
CP + CPA	10-100 %		1+n*	1	●	●	●					
CP + CPB							●					
aMotion	10-100 %	●	4	2	●	●	●	●	●	●	●	●

*parallel connection of other external inputs possible

CP CONTROLS - BUILT-IN CONTROL MODULE

Comfort control system offers intuitive operation and a wide range of adjustable parameters. The system allows the connection of an external input to increase the ventilation power (signals from rooms, e.g. toilet, bathroom, kitchen), 0-10 V input for power control according to air quality sensors (CO₂, rH). It is also possible to connect an integrated or external electric preheater (to

protect the heat exchanger from a freezing) and a reheater (to achieve the requested supply air temperature). The control also provides the possibility of controlling the shut-off dampers on the supply and extract. The uniqueness of the system is underlined by the **CPA wall-mounted digital touch controller**. As an alternative to the touch controller, a simple **mechanical CPB controller** can be used.

CP CONTROL WIRING DIAGRAM

POWER
Required wiring...
Optional wiring...

POWER

230 V, 50 Hz (CYKY 5×1,5 mm²)

Power supply for unit and integrated heater/preheater

Fuses – 16 A, char. C

CONTROL

Input of wires to the unity

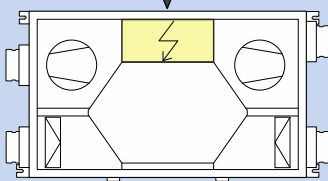

CPA



Sensor air quality (CO₂, humidity VOC)



BOOST buttons



SYKFY 5×2×0,5
max. length 25 m

SYKFY 2×2×0,5

SYKFY 2×2×0,5

Mandatory 2× external input (CO₂ sensor OR button)

OR

CPB



Sensor air quality (CO₂, humidity VOC)



BOOST buttons



SYKFY 5×2×0,5
max. length 25 m

SYKFY 2×2×0,5

SYKFY 2×2×0,5

Mandatory 2× external input (CO₂ sensor OR button)

OPTIONAL ACCESSORIES

CYKY 30×1,5

SYKFY 2×2×0,5

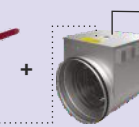
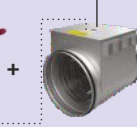

duct thermostat

external electric pre-heater

duct thermostat

external electric post-heater

CYKY 3J×2,5

Fuses 10 A, charB

CONTROLLERS FOR CP CONTROLS

CPA controller

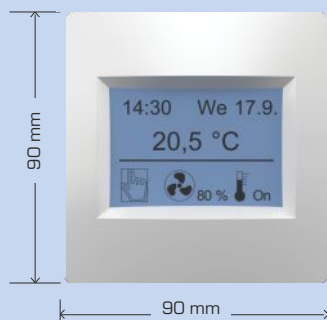

CPB controller

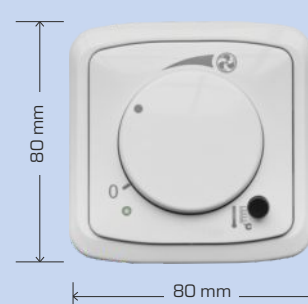

aMOTION CONTROLS – ADVANCED CONTROL SYSTEM MODULE

Main functions of the aMotion control module:

- Possibility to adjust ventilation power and other parameters according to weekly program
- Autonomous frost protection of the heat exchanger
- BOOST based on push-button signal (kitchen, bathroom or toilet) with selectable delay
- Continuous control of electric preheater and electric or water heater
- Control of shut-off dampers on the fresh water supply pipe and exhaust air
- Control of zone dampers on supply and extract air (priority kitchen extraction)

CONTROL WITH aMOTION MODULE

Units with the aMotion control module can be controlled in several ways:

- a)** **aTouch** controller – this is a wall-mounted controller with a size 4,3" touch screen. The controller allows you to perform all user settings.
 - b)** **aDot** controller – this is a simplified wall-mounted touch controller. The controller allows you to perform the most important user settings.
 - c)** Without the controller, use **a computer** or **mobile phone** via the built-in webserver or via the aSpace cloud service.
 - d)** Without the controller, the control based on the measured value from the air quality sensors (CO₂, humidity, VOC) or based on the detection of one of the BOOST buttons.
 - e)** Using a superior control system, by default using the Modbus TCP protocol.
- The individual control options a) to e) can be combined with each other.

aMOTION controllers

aTouch controller



aDot controller (in white and black)

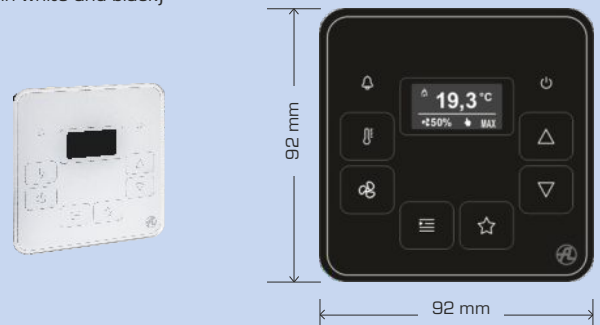

CONTROL SYSTEM – aMOTION

aMOTION CONTROL WIRING DIAGRAM

POWER

Required wiring
Optional wiring...

POWER

230 V, 50 Hz (CYKY 5×1,5 mm²)

Power supply for unit and integrated heater/preheater

Fuses – 16 A, char. C

CONTROL

WEB server / nadřazený systém
(ModBus TCP)



UTP CAT 5e

SYKFY 2×2×0,5 / CYKY 20×1,5

Sensor air quality
(CO₂, humidity VOC)



SYKFY 2×2×0,5

BOOST buttons



CYKY 20×1,5

Mandatory 2× external input (CO₂ sensor OR button)

OR

aTouch



SYKFY 2×2×0,5
max. length 50 m

SYKFY 2×2×0,5 / CYKY 20×1,5

Sensor air quality
(CO₂, humidity VOC)



SYKFY 2×2×0,5

BOOST buttons



CYKY 20×1,5

Mandatory 2× external input (CO₂ sensor OR button)

OR

aDot



SYKFY 2×2×0,5
max. length 50 m

SYKFY 2×2×0,5 / CYKY 20×1,5

Sensor air quality
(CO₂, humidity VOC)



SYKFY 2×2×0,5

BOOST buttons



CYKY 20×1,5

Mandatory 2× external input (CO₂ sensor OR button)

Input of wires to the unity

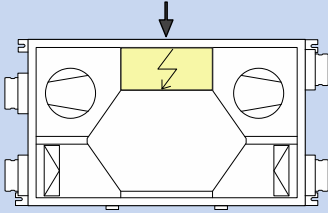

OPTIONAL ACCESSORIES

Basic aM control module
(aM-CE)

CYKY 30×1,5

SYKFY 2×2×0,5

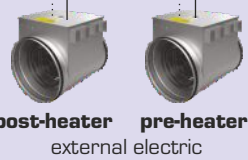

post-heater external electric
pre-heater
+
ANS duct temp. sensor

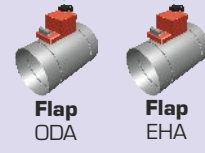

Flap ODA
Flap EHA

CYKY 3J×2,5

Fuses 10 A, char.B

Basic aM control module
(aM-HO18)

CYKY 30×1,5

SYKFY 2×2×0,5



BOOST buttons



Z1
Z2
Supply zone flaps



Switching flap
for exhaust zone

External water heater



Throttle valve



CYKY 30×1,5

Circulation pump



CYKY 3J×1,5

ANS 120 duct temp. sensor



SYKFY 2×2×0,5

BUILT-IN ELECTRIC PREHEATERS EDO



- when used as a **pre-heater** it also works as one of the frost protection of the heat recovery core
- designed for to be **built-in into the unit**, installation at a predetermined place inside the unit incl. the installation frame
- operating temperature control is ensured by the unit control system
- the element is prepared for the easy installation into the unit incl. the cables
- the heater is equipped with SSR switch
- iBuilt-in EDO heaters don't reduce the pressure reserve of the unit
- it is equipped with two safety reverse acting thermostats (60 °C reversible and 90 °C manual reset)

DUCT ELECTRIC HEATER EPO-V



- used for the fresh air **preheating**, installing in the duct at the fresh air inlet
- to be used for the supply air **reheating**, installing in the duct downstream the unit
- it is required to be used a thermostat in the duct behind the heater together with CP controls
- the casing is made of galvanized metal sheet
- the casing includes the terminal board
- IP44 protection, to be installed only in normal environment
- it is equipped with two safety thermostats reversible (60°C returnable and 120°C manual reset)
- the heater is equipped with SSR switch
- the safety reset button is located on the heater cabinet casing, during the assembly the heater must be located with regard to access and must not be fitted with a cover downward
- minimum airflow in the heater is 1,5 m/s

typ	power input (kW)	voltage (V)	min. air. flowrate (m ³ /h)	ø D (mm)
EPO-V 125/0,9	0,9	230	45*	125
EPO-V 160/1,6	1,6	230	110*	160
EPO-V 200/2,0	2,0	230	170*	200
EPO-V 250/3,0	3,0	400	260*	250

*If requested lower flowrate than shown here, please use the built-in EDO integrated heaters.

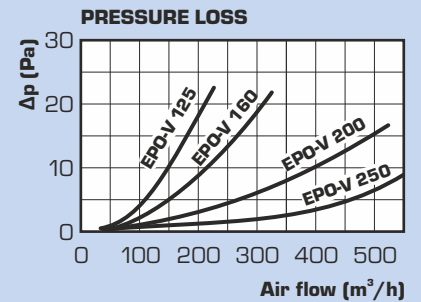

Heater placement diagram

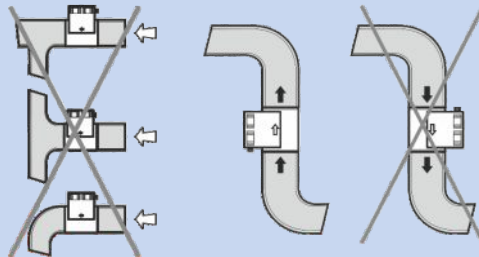
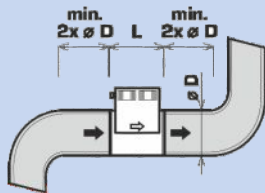

Permitted terminal board positions

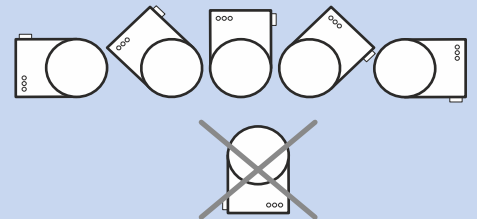

OPTIONAL ACCESSORIES

SELECTION OF HEATERS

Units with CP controls			
DUPLEX	200 Easy2	300 Easy2	500 Easy2
integrated electric preheater	EDO - 1,1 - CP (Pro-V, Easy2, Slim) A160660		EDO - 2,2 - CP (Easy2) A160668
integrated electric reheater	cannot be integrated into these units		
external electric preheating	EPO-V 125/0,9 A150101	EPO-V 160/1,6 A150102	EPO-V 200/2,0 A150103
	+ Duct thermostat for EPO-V A150199		
external electric preheat	EPO-V 125/0,9 A150101	EPO-V 160/1,6 A150102	EPO-V 200/2,0 A150103
	+ Duct thermostat for EPO-V A150199		

Units with aM controls			
DUPLEX	200 Easy2	300 Easy2	500 Easy2
integrated electric preheater	EDO - 1,1 - aM (Pro-V, Easy2, Slim) A160662		EDO - 2,2 - aM (Easy2) A160669
integrated electric reheater	cannot be integrated into these units		
external electric preheating	EPO-V 125/0,9 A150101	EPO-V 160/1,6 A150102	EPO-V 200/2,0 A150103
	+ * ANS 120 (duct temperature sensor) A145620		
external electric preheat	EPO-V 125/0,9 A150101	EPO-V 160/1,6 A150102	EPO-V 200/2,0 A150103
	+ ANS 120 (duct temperature sensor) A145620		

A wider range of electric preheaters and reheaters is configurable in the ATREA selection software.
*Optional pipe temperature sensor for cases with long distance between preheater and recovery unit.

HOT WATER AIR HEATERS TPO EC THV



- to be used to reheat the air, to be installed in ducts (can be used only with a.Motion control system)
- ANS 120 sensor required (to be installed in the duct downstream the heater)
- painted metal sheet casing
- aluminium lamellas on copper tubes
- maximum operating pressure 10 bar
- maximum operating temperature 70 °C
- as a standard the heater is supplied included the throttle valve equipped with servo drive (24V power supply, 0-10V control)

air flow rate (m ³ /h)	water flow rate (l/h)	pressure loss (kPa)	heating power* (kW)
100	30	0,1	0,3
150	40	0,2	0,5
200	60	0,3	0,8
300	80	0,6	1,3
400	100	0,9	1,9
500	120	1,3	2,5

* The table applies for heating water temperature 55 / 35 °C, supply air after heat recovery 15-20 °C, exhaust air min. 30 °C. Parameters for different conditions can be found in the ATREA selection software.

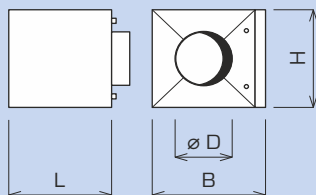

typ	ø D (mm)	B (mm)	H (mm)	L (mm)	připojení (")	recommended for DUPLEX
TPO 125 EC THV	125	418	348	350	1/2" (e)	200 Easy2
TPO 160 EC THV	160	418	348	350	1/2" (e)	300 Easy2
TPO 200 EC THV	200	418	348	350	1/2" (e)	500 Easy2
TPO 250 EC THV	250	418	348	350	1/2" (e)	500 Easy2

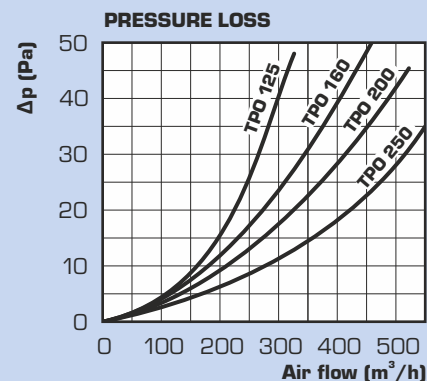

MODULAR AIR HANDLING SYSTEM OF ATREA

DUPLEX Easy2 UNITS

	DUPLEX 200 Easy2.CP	Order no. A161300
	DUPLEX 300 Easy2.CP	Order no. A161301
	DUPLEX 500 Easy2.CP	Order no. A161302
	DUPLEX 200 Easy2.aM	Order no. A161310
	DUPLEX 300 Easy2.aM	Order no. A161311
	DUPLEX 500 Easy2.aM	Order no. A161312

SPARE FILTER CASSETTES

	FK 150 (150 P, 200 E2) - G4	Order no. A160685
	FK 150 (150 P, 200 E2) - F7	Order no. A160688
	FK 300 (300 - 500 E2) - G4	Order no. A160697
	FK 300 (300 - 500 E2) - F7	Order no. A160698

Spare air filters are delivered in package of 1 pc.

OPTIONAL ACCESSORIES - SENSORS

	ADS SMOKE 24 room sensor for cigarette smoke and air quality	Order no. A142311
	ADS RH 24 room humidity sensor - relative humidity sensor	Order no. A142318
	ADS CO₂ 24 room sensor continuously controlling the ventilation power according to the current CO ₂ value	Order no. A142319
	ADS VOC 24 room air quality sensor	Order no. A142331
	ADS CO₂ D duct sensor continuously controlling the ventilation power according to the current CO ₂ value	Order no. A142330
	SI2504 movement sensor	Order no. A142333
	HYG 6001 room hygrosstat - relative humidity sensor	Order no. A142303
	ANS 100 ABB room temperature sensor design ABB, (white colour)	Order no. A145601
	ANS 110 outdoor temperature sensor	Order no. A145610

OPTIONAL ACCESSORIES - FLEXIBLE FLANGES

	H.D125.P flexible flange circular (round) diam. 125mm	Order no. A131163
	H.D160.P flexible flange circular (round) diam. 160mm	Order no. A131161
	H.D200.P flexible flange circular (round) diam. 200mm	Order no. A131160

OPTIONAL ACCESSORIES - FLEXIBLE FITTING

	SB5 - silent block set	Order no. A160530
--	-------------------------------	-------------------

CONTROLLERS

	Controller aTouch 4,3 4,3" colour touchscreen remote control	Order no. A145500
	Controller aDot (B) design controller with display - basic print - black	Order no. A145550
	Controller aDot (W) design controller with display - basic print - white	Order no. A145551
	Controller CPA - cover colour changeable - touch	Order no. A144100 coloured covers see price list
	Controller CPB - color white	Order no. A144110
	aM-IO18 unmounted aMotion Input/Output board with 18 terminals	Order no. A145310
	aM-D4 aMotion control expansion module for 4 inputs of 230V	Order no. A145353
	RD-BACnet/KNX aMotion control expansion module	Order no. A170288

OPTIONAL ACCESSORIES - AIRHEATERS

	EPO-V 125/0,9	Order no. A150101
	EPO-V 160/1,6	Order no. A150102
	EPO-V 200/2,0	Order no. A150103
	EPO-V 250/2,0	Order no. A150116
	EPO-V 250/3,0	Order no. A150105
	TPO 125 EC THV	Order no. A160212
	TPO 160 EC THV	Order no. A160213
	TPO 200 EC THV	Order no. A160214
	TPO 250 EC THV	Order no. A160215
	ANS 120 Duct temp. sensor ANS 120 required for EPO-V heaters or TPO EC THV heaters (aMotion controls)	Order no. A145620
	Termostat potrubní pro EPO-V nutné pro předehříváče nebo dohříváče EPOV (regulace CP)	Order no. A150199

OPTIONAL ACCESSORIES - AIR PREHEATERS

	EDO - 1,1 - CP (200 - 300 Easy2)	Order no. A160660
	EDO - 2,2 - CP (500 Easy2)	Order no. A160668
	EDO - 1,1 - aM (200 - 300 Easy2)	Order no. A160662
	EDO - 2,2 - aM (500 Easy2)	Order no. A160669

OPTIONAL ACCESSORIES - SHUT-OFF DUMPERS

	K.D125.LM24A shut-off dumper with servo drive circular (round) diam. 125mm	Order no. A130191
	K.D160.LM24A shut-off dumper with servo drive circular (round) diam. 160mm	Order no. A130190
	K.D200.LM24A shut-off dumper with servo drive circular (round) diam. 200mm	Order no. A130192

www.atrea.eu