

DUPLEX

1500 to 6500 MultiEco-V

All-purpose ventilation units
with counterflow heat exchangers

– upright

DUPLEX 1500–6500 MultiEco-V is a new generation of all-purpose ventilation units with counterflow heat recovery exchangers in upright configuration.

The indoor version of compact DUPLEX 1500–6500 MultiEco-V units are used for comfort ventilation, hot-air heating and cooling in small facilities, shop floors, stores, schools, restaurants, shops, sports and industrial halls. The units are intended for indoor operation in covered and dry areas. They are suitable wherever efficient ventilation and possibly hot-air circulation ventilation and cooling must be provided at minimum running cost, i.e. the highest efficiency of heat recovery, low power input of fans and as little noise as possible.

DUPLEX MultiEco-V units are compact appliances containing in a single cabinet two independently controlled EC fans with backward curved blades a heat recovery exchanger with large heat-transfer surface and high efficiency, slide-out supply and exhaust air class G4, M5 or F7 filters, drain pans and possibly also an internal bypass with a servo drive and a circulation damper with a servo drive.

The cabinet has a sandwich structure and consists of silver painted metal sheet (colour RAL 9006) and 30 mm of PIR fill with an outstanding heat transfer coefficient ($\lambda = 0,024 \text{ W/mK}$).

DUPLEX MultiEco-V ventilation units meet the requirements of the most stringent European standards:

- Casing properties according to EN 1886
- EC motors according to ErP 2015
- SFP < 0,45 W/(m³/h) according to PassivHaus*
- Hygienic requests according to VDI 6022
- Commission regulation (EU) requirements No. 1253/2014 (Ecodesign)



Advantages of DUPLEX MultiEco-V units:

- New design of ventilation units with excellent parameters
- Great thermal insulation of the casing (class T2)
- Reduced thermal bridging (class TB1)
- Compact dimensions
- Ease of installation
- Unified dimensions of ports
- Optional versions with a bypass and circulation damper
- High efficiency fans – SFP < 0,45 W/(m³/h)*
- High heat recovery efficiency of the counterflow heat exchanger – up to 93 %
- Integrated control system including temperature sensors
- Integrated web server (aMotion regulation)
- Comprehensive design software

* in the defined working area



1500 to 6500 MultiEco-V

AVAILABLE MODIFICATIONS (CAN BE COMBINED)

- | | | | |
|-----|----------------------------------|-------|-----------------------------------|
| - B | with in-built bypass damper | - T | with in-built hot-water heater |
| - C | with in-built circulation damper | - CHF | with in-built direct chiller |
| - E | with in-built electrical heater | - CHW | with in-built water-based chiller |

OPERATING MODES OF DUPLEX MULTIECO-V UNITS

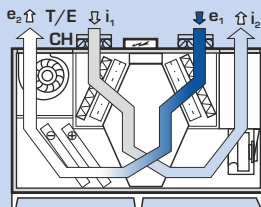

Ventilation with heat recovery
with re-heating (with cooling)

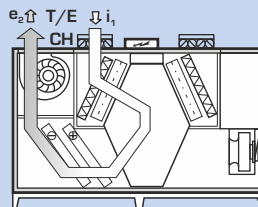

Circulation heating
or cooling

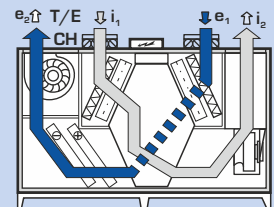

Ventilation without heat recovery
(via bypass)

- e₁ ... Fresh outdoor air suction
↺ e₂ ... Fresh filtered air outlet

- ↻ i₁ ... Exhaust air suction
↻ i₂ ... Exhaust air outlet

- T/E... Central heating / electrical heater connection
CH ... Cooling connection

SELECTION SOFTWARE



For the detailed design of DUPLEX series units, accessories and control systems we recommend using our dedicated design software. You can find it on our website at www.atrea.eu or request a CD at our office.

Atrea[®]

UNIT VENTILATORS & HEAT RECOVERY

ATREA s.r.o., Čs. armády 32
466 05 Jablonec n. Nisou
Czech Republic



www.atrea.eu

Phone: +420 483 368 111
Fax: +420 483 368 112
E-mail: atrea@atrea.eu

PERFORMANCE GRAPHS

BASIC PARAMETERS

DUPLEX MultiEco-V		1500	2500	3500	4500	5500	6500
Supply air – max. ¹⁾	m ³ h ⁻¹	2 050	3 050	5 400	5 900	7 400	7 800
Extraction air – max. ¹⁾	m ³ h ⁻¹	1 800	2 700	5 300	5 400	7 000	7 700
Max. nominal airflow according to ErP 2018 ⁵⁾	m ³ h ⁻¹	1 600	2 350	3 300	3 900	4 750	5 750
Heat recovery efficiency ²⁾	%	up to 93 %					
Number of versions and positions	–	2					
Weight ³⁾	kg	210–290	300–380	360–430	380–460	490–570	590–680
Max. power input	kW	1,2	2,3	5	5	6,6	6,6
Voltage	V	230	400	400	400	400	400
Frequency	Hz	50					
Revolutions – max.	min ⁻¹	2 920	3 000	2 980	2 980	2 700	2 700
Heating output E low – max. ⁵⁾	kW	2,1	4,2	7,2	7,2	9,9	9,9
Heating output E high – max. ⁵⁾	kW	4,2	8,4	10,8	12,6	14,7	14,7
Heating output T – max. ⁴⁾	kW	22	30	42	51	71	88
Cooling output CHW – max. ⁴⁾	kW	16	22	30	42	56	62
Cooling output CHF – max. ⁴⁾	kW	10	13	25	37	41	50

¹⁾ Maximum flow rate through units at zero external pressure

²⁾ According to air volume

³⁾ Depending on equipment

⁴⁾ Depending on register type, liquid and flow rates

⁵⁾ For detailed information please use our DUPLEX selection software.

PERFORMANCE SUMMARY

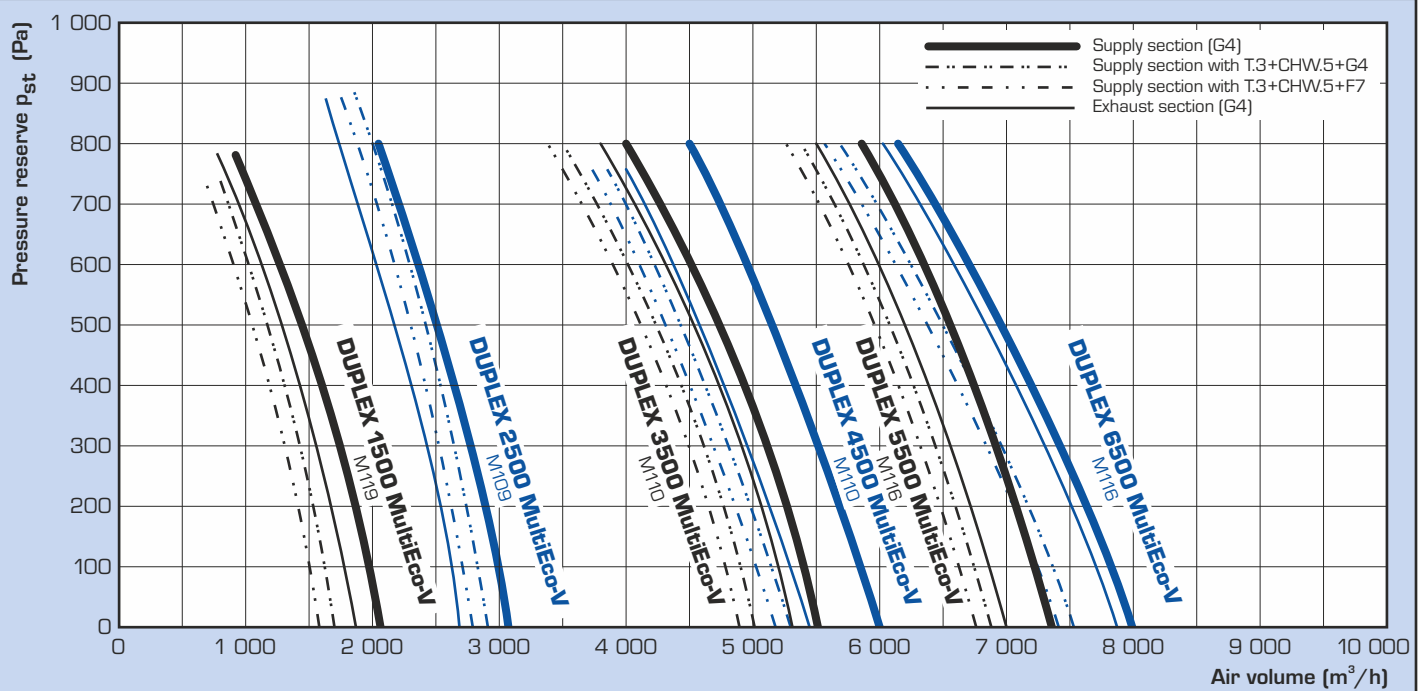

HEAT RECOVERY EFFICIENCY

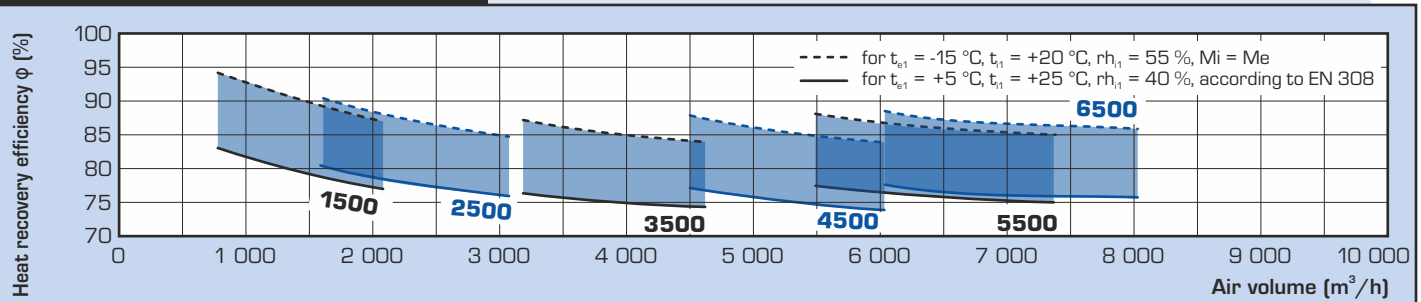

HEATING AND COOLING PERFORMANCES

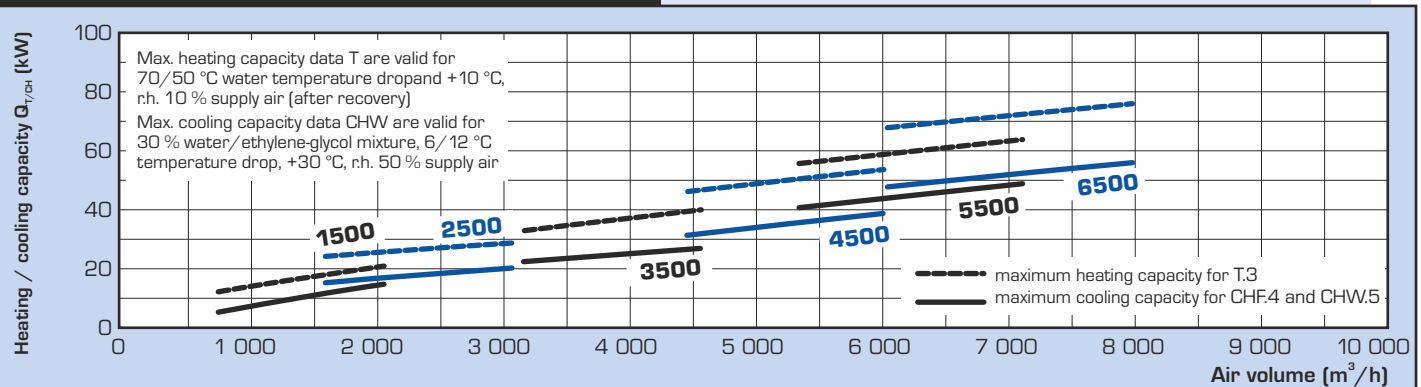

BASIC DIMENSIONS

UPRIGHT MultiEco-V 1500 to 8000

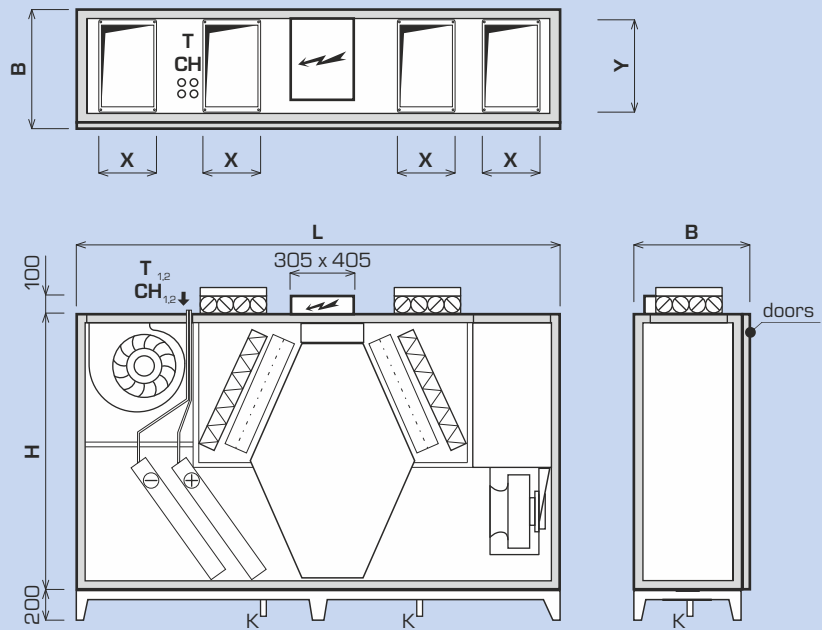

DUPLEX MultiEco-V		1500	2500	3500	4500	5500	6500
Dimension H	mm	1 600	1 600	1 600	1 600	1 600	1 600
Dimension B	mm	455	580	775	885	1 065	1 290
Length L	mm	2 600	2 600	2 800	2 800	2 800	2 800
Condensate drain line	mm	ø 32					
Connecting ports							
Dimension X x Y	mm	300 x 250	300 x 400	400 x 400	400 x 600	400 x 710	400 x 900

TYPES AND DIMENSIONS OF CONNECTING PORTS

Basic port
(inlet, outlet)

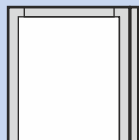

Port with flexible flange
(inlet, outlet)

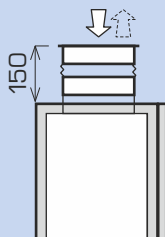

Port with damper
(inlet only)

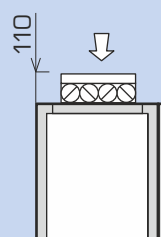

Port with damper and flexible flange
(inlet only)

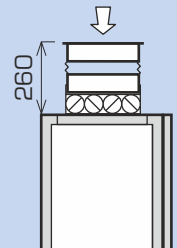

For more detailed technical information check out ATREA selection software.

INSTALLATION AND VERSIONS

INSTALLATION VERSIONS AND CONNECTING PORTS

DUPLEX 1500 to 6500 MultiEco-V units are available in 2 configurations to facilitate their installation in the machine room.

DUPLEX MultiEco-V units are characterised by a wide range of accessories – the ports may be optionally fitted with flexible flanges and inlet ports may have shut-off dampers if required.

MOUNTING POSITIONS

UPRIGHT POSITION

MultiEco-V 1500 to 6500

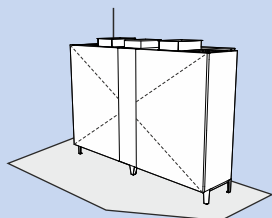

configuration 50/0 – door-side view

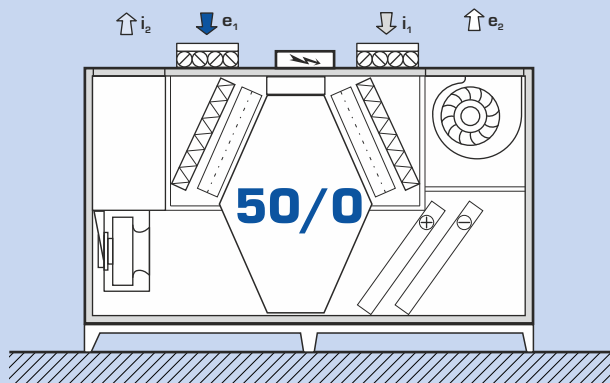

configuration 51/0 – door-side view

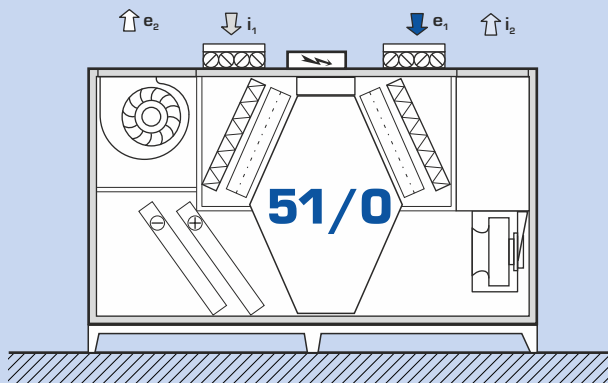

For more detailed technical information check out ATREA selection software.

OTHER CONFIGURATIONS OF DUPLEX MULTIECO

FLOOR-STANDING

DUPLEX MultiEco 500 to 9000

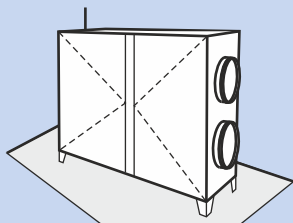

UNDER-CEILING

DUPLEX MultiEco 500 to 6500

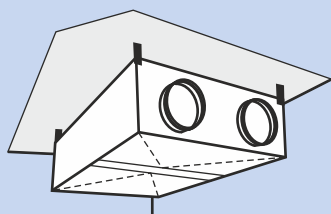

FLOORSTANDING - FLAT

DUPLEX MultiEco 1500 to 5500

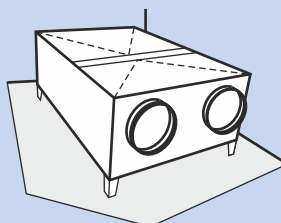

ROOFTOP UNITS - FLAT

DUPLEX MultiEco-N 1500 to 9000

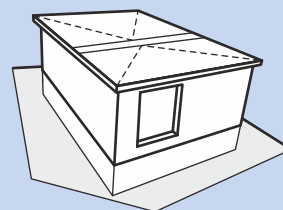

For detailed information please see separate technical catalogues.

HANDLING SPACE

DUPLEX units must be installed with the prescribed handling space around the unit in mind.

Below the unit at least 150 mm must be left to install the DN 32 condensate drain line. This line must run through a U-bend at least 150 mm high into a sewer. This space is easily provided when the steel supporting feet supplied as standard are used. Handling space in front of the unit must be maintained for opening the front door; replacing filters and providing servicing and installation access to each unit part.

Each drawing shows the minimum handling space.

In addition, each unit must have the minimum handling space of 600 mm from the side of the control system electric switchboard according to CSN.

Handling space in front of the door

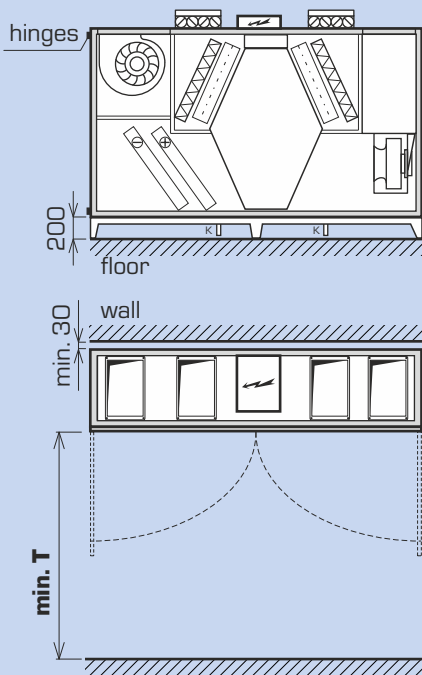

Handling space for accessories control modules

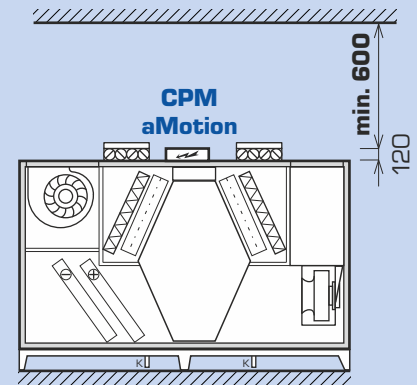

Type	standard door T (mm)	hingeless door T (mm)
DUPLEX 1500 MultiEco-V	1 400	500
DUPLEX 2500 MultiEco-V	1 400	600
DUPLEX 3500 MultiEco-V	1 500	680
DUPLEX 4500 MultiEco-V	1 500	900
DUPLEX 5500 MultiEco-V	1 500	1 100
DUPLEX 6500 MultiEco-V	1 500	1 300

ACOUSTIC POWER L_w AND ACOUSTIC PRESSURE L_{p_3}

Type	Working point	Acoustic power L_w [dB(A)]					Acoustic pressure L_{p_3} [dB(A)] at distance of 3 m
		inlet e_1	inlet i_1	outlet e_2	outlet i_2	unit	
DUPLEX 1500 MultiEco-V	1 500 m ³ /h (200 Pa)	54	59	81	81	66	45
DUPLEX 2500 MultiEco-V	2 500 m ³ /h (200 Pa)	66	70	82	91	76	55
DUPLEX 3500 MultiEco-V	3 500 m ³ /h (200 Pa)	64	63	91	91	74	52
DUPLEX 4500 MultiEco-V	4 500 m ³ /h (200 Pa)	67	67	92	88	66	58
DUPLEX 5500 MultiEco-V	5 000 m ³ /h (200 Pa)	69	70	95	93	68	61
DUPLEX 6500 MultiEco-V	6 000 m ³ /h (200 Pa)	72	75	96	88	78	59

MODIFICATIONS

DUPLEX MULTIECO-V - BASIC UNIT



Basic configuration

The compact unit consists of supply and exhaust centrifugal fans with electric motors in anti-vibration mounting, removable counterflow air-to-air heat recovery core assembled from thin plastic plates, removable G4, M5 or F7 supply and exhaust air filters, and a condensate pan with flexible hose. A front door enables easy access to all built-in components and filters. The units meet requirement in accordance with Commission regulation (EU) No. 1253/2014 (Ecodesign) in the defined working area.

DUPLEX xxxx MultiEco-V



Fans

All units are equipped with high-efficiency fans (ebm-papst and Ziehl Abegg) with free-running impellers and backward curved blades. Whole range of DUPLEX 1500 to 6500 MultiEco-V fans meets the requirements of the European directive ErP 2015.

Me.xxx; Mi.xxx

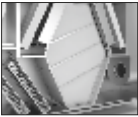

Heat recovery core

The only heat recovery core type S7 made of plastic in counterflow arrangement with high efficiency - up to 93 %.

S7

DUPLEX MULTIECO-V - MODIFICATION DESCRIPTION



By-pass („B“)

By-pass of the plate heat recovery core on supply air side. By-pass consists of an opposed-blade damper and an actuator. It is fitted next to the recovery core inside the unit; it does not increase size of the unit. The standard actuator is BELIMO 24 V; other types are available upon request.

B.x



Mixing damper („C“)

The mixing damper is used to mix exhaust and supply air. Circulation valve consists of an opposed-blade damper and actuator. It is fitted next to the recovery core inside the unit, it does not increase the size of the unit. The standard actuator is BELIMO 24 V; other types are available upon request.

C.x

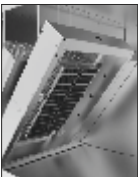

Electric heating coil („E“)

Integrated electric heating coils consist of PTC (Positive Temperature Coefficient) cells; they are generally used to heat up supply air. By default, electric heating coils always include protective thermostats (operational as well as emergency with manual reset) and regulation module KM featuring power switching elements with so called "zero" switching function (SSR). Built-in electric heating coils are offered in the 1500-6500 MultiEco-V units in two power options (basic and powerful). For more information please refer to the selection software DUPLEX.

E.x

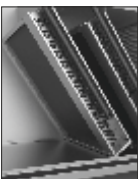

Hot water heating coil („T“)

Built-in water-to-air three-row (possibly five-row) heating coil; made of copper pipes and aluminum fins. Designed for systems up to 110 °C and 1,0 MPa. The coil is standardly equipped with flexible connection and a steam-gas capillary thermostat for freeze protection. Units in modification T (with heating coil) must be equipped with e, supply air shutoff damper; an actuator with spring-return function is recommended. An external coil hydraulic kit for heating capacity control of RE-TPO4 or RE-TPO3 type can be supplied with the coil upon request.

T.x

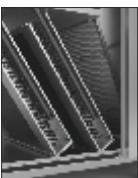

Direct expansion (DX) coil („CHF“)

A built-in coil made of copper pipes and aluminum fins, including a condensate pan with individual condensate drainage and a pressure switch for freeze alarm. Three- or four-row coils with various evaporate temperature are chosen depending on capacity required, refrigerant type and air parameters. Optionally it is possible to deliver double-circuit evaporator in division 1:1 or 1:2, or completely atypical with needed capacity.

CHF.x

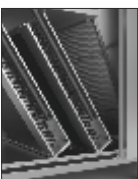

Chilled water cooling coil („CHW“)

A built-in coil made of copper pipes and aluminum fins, including a condensate pan with individual condensate drainage. Three- or five-row coils are chosen depending on capacity required, cooling medium type and air parameters. The cooling coil can be equipped with the R-CHW2 or R-CHW3 external hydraulic kit on request.

CHW.x

OTHER OPTIONAL ACCESSORIES (BASIC OVERVIEW)

Shutoff damper e₁; i₁

Ke.xxx; Ki.xxx



Shutoff dampers standardly fitted with BELIMO actuators are located in the air inlet port. The following damper types are available:

- fresh air damper e₁ - mandatory for C modification (with mixing damper) and T modification (with heating coil)
- exhaust air damper i₁

Air filtration

Fe.xxx; Fi.xxx



All DUPLEX MultiEco-V units can be equipped with supply or exhaust air filtration of M5 or F7 class instead of standard G4 class. Pressure drop of the filter is then 50 to 100 Pa (clean filter) depending on air flow rate, unit type and dirt accumulated.

Heating coil hydraulic kit

RE-TPO.x



Its function is to control heating capacity of a heating coil. It consists of a three-speed pump, two globe shutoff valves and connection pipes. Further equipment depends on the type:

- RE-TPO4 - four-way mixing valve with an actuator for digital control system
- RE-TPO3 - three-way mixing valve with an actuator for digital control system

Cooling coil hydraulic kit

R-CHW.x



Its function is to control cooling capacity of a chilled-water cooling coil. It always consists of two globe shutoff valves and connection pipes. Further equipment depends on the type:

- R-CHW3 - three-way mixing valve with an actuator
- R-CHW2 - throttling valve with an actuator for digital control system

Tube manometers

MFF



Accessory for filters for simple view of current pressure drop. The tube manometers are obligatory for hygienic unit design in accordance with the VDI 6022.

Spare cartridge filters

FK.x



Replacement filter cartridges in different sizes based on the unit type. Available in G4, M5 and F7 filtration class.

Delivery of disassembled unit

All units can be delivered dismantled on request. The unit is to be assembled by rivets and bolts directly on site, therefore the unit can be installed in inaccessible location. Casing insulation class T2, thermal bridging class TB1.

Flexible connections

H.P



Round and rectangular ports can be equipped with flexible connections upon request.

Hot water heating coil (TPO)

TPO



Separately supplied coil for installation into round duct. It is suitable for cramped locations, where it is impossible to put the coil inside the unit, as well as for rooftop units. The coil is standardly equipped with the steam-gas capillary thermostat. Capacities and diameters can be found in respective catalogue sheets.

Electric heating coil (EPO-V)

EPO-V



Separately supplied heating coil to be fitted into round or rectangular duct. Capacities and diameters can be found in respective catalogue sheets.

Constant air flow and pressure

CF.XXX



Manometers reading fan pressure together with controls, enables intelligent fan control of preselected airflow. This accessory assumes the unit is equipped with digital controls of aMotion type. Using a second manometer (optional accessory) in the supply air duct enables the user to control constant pressure in the supply duct.

Electric preheaters EPO-V

EPO-V



EPO-V electric heating coils to provide the antifreeze protection of the heat recovery exchanger when equal-pressure ventilation is continuously required. It is installed inside a duct on the outdoor supply air side of the unit (e.). Control is provided through the DUPLEX aMotion unit control system.

Hingeless door

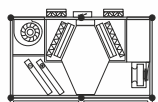

When needed it is possible to deliver door without standard hinges - than necessary manipulation space is reduced.

CONTROLS





DUPLEX MultiEco-V units are delivered with basic control components or with complete control systems.

There are three types of control systems available (basic, CPM and aMotion) according to customer needs and an application. The systems also include variety of sensors (temperature, humidity, air quality, CO₂) for effective operation control.

Features of the control systems

- selection of the most suitable and efficient control system at the lowest cost, depending on the particular application
- control system is integrated with the unit, most components are already wired and checked in factory, thus reducing the risk of incorrect wiring
- no control system project documentation is necessary for standard cases, standardized solutions can be used
- simple wiring, system simplicity, error indication
- qualified technical support and consulting

SUMMARY OF DUPLEX MULTIECO-V CONTROL SYSTEMS

Type	Use	Controller
"Basic" controls	<ul style="list-style-type: none"> - all electrical components are wired to a junction box terminal strip inside or outside the unit - standard components are fans, damper actuators, capillary freeze protection thermostat of hot water heating coil - more components are included upon customer's request (exact actuator type, sensors, thermostats, pressure switches etc.) - suitable for applications with separate delivery of control system; e.g. large buildings with central control system etc. 	<div style="border: 1px solid black; padding: 5px; text-align: center;"> <p>basic version (fans, actuators, thermostats, pressure switches and others on request)</p> </div> <p style="text-align: center;">↑ ↓</p> <div style="border: 1px solid black; padding: 5px; text-align: center;"> <p>Supervisory control system</p> </div>
"CPM" controls	<p>Standard functions</p> <ul style="list-style-type: none"> - EC fan speed control (stepless) - automatic by-pass damper position - frost protection of heat exchanger - switching of electric or water heater - input for external switch - inlet and outlet shut-off damper control - minimum and maximum fan speed preselection - analogue input (0-10 V) for air quality sensor (CO₂, RH) - outputs for controlling electrical preheater and heater (pulse switched 10 V) or water heater (controlled by 0-10 V signal) - outputs for controlling cooling (direct or water), eventually heat pump <p>Controller CPM</p> <ul style="list-style-type: none"> - fully graphic touchscreen - weekly program - „party" mode - „holiday" mode - filter change notice - automatic operation based on constant signal - e.g. constant pressure <p>Controller CP 10 RA</p> <ul style="list-style-type: none"> - rotatable controller 	<div style="text-align: center;">  <p>CPM controller with touchscreen display</p> </div> <div style="text-align: center; margin-top: 20px;">  <p>CP 10 RA with mechanical knob</p> </div>
"aMotion" controls	<p>Standard aMotion control functions</p> <p>Elementary aM-CE basic module</p> <ul style="list-style-type: none"> - EC fans speed control (according to selected mode) - Automatic heat and cool recovery control (by-pass control) - Evaluates and prevents all emergency conditions according to the measured values - Possibility of setting basic and user scenes and weekly calendars to select modes, power, temperatures and other functions - Ethernet connection for communication over the Internet - Inputs for external signals - control e.g. from kitchens, toilets and similar - Possibility of connecting air quality sensors (e.g. CO₂ concentration or relative humidity) either by contact, 0-10V voltage, or via the bus. - Outputs for continuous control of electric preheater and heater (pulse switched 10 V) - Possibility of connecting up to two controllers of different types - Connection to supervisory control system via Modbus TCP protocol <p>Legendary aM-CL advanced module (with all functions from Elementary aM-CE module and additional options below)</p> <ul style="list-style-type: none"> - Control of systems with VAV boxes - Control of systems with heat sources (heat pumps, heat accumulators etc.) - Communication by BACnet protocol over the bus - Possibility of connecting more than two controllers - More than 4 external bus elements (controllers, CO₂ sensors, outdoor temperature sensors,...) - Multiple adjustable scenes (more than 10) - More than 2 user calendars - More than 4 users (excluding service access) <p>Additional module aM-IO18</p> <ul style="list-style-type: none"> - Inputs for 4 external signals - control from kitchens, toilets and similar - Hot water heater control (0-10 V) - Control of circulation modes <p>Additional module aM-IO12</p> <ul style="list-style-type: none"> - Control of cooling (direct and water) and heat pumps - Rotary regenerator <p>Additional aM-XCF</p> <ul style="list-style-type: none"> - Unit control based on flow measurement <p>Additional RD-K module</p> <ul style="list-style-type: none"> - Additional inputs and outputs significantly expanding the control system functionality <p>BACnet / KNX converter</p> <ul style="list-style-type: none"> - Connection to the superior system via BACnet or KNX protocol 	<p>aTouch (touchscreen)</p> <div style="text-align: center;">  </div> <p>aDot (touchscreen)</p> <div style="text-align: center;">  </div> <p>aSpace (internet interface)</p> <div style="text-align: center;">  </div>