

# DUPLEX

## 500 to 11000 Multi

All-purpose ventilation units  
with counterflow  
heat exchangers

DUPLEX 500–11000 Multi is a new generation of all-purpose ventilation units with counterflow heat recovery exchangers. The indoor version of compact DUPLEX 500–11000 Multi units are used for comfort ventilation, hot-air heating and cooling in small facilities, shop floors, stores, schools, restaurants, shops, sports and industrial halls. They are suitable wherever efficient ventilation and possibly hot-air circulation ventilation and cooling must be provided at minimum running cost, i.e. the highest efficiency of heat recovery, low power input of fans and as little noise as possible.

DUPLEX Multi units are produced in compact (500 to 8000 Multi) and semi-compact (10000 to 11000 Multi) version and contain two independently controlled EC fans with backward curved blades, a heat recovery exchanger with large heat-transfer surface and high efficiency, slide-out supply and exhaust air class G4, M5 or F7 filters, drain pans and possibly also an a circulation damper with a servo drive or integrated air heaters and coolers.

Unit casing is divided into two versions:

DUPLEX 500–8000 Multi are frameless construction, casing is made of painted metal sheet (colour RAL 9006) with 30 mm PIR insulation with heat transfer coefficient ( $\lambda = 0,024 \text{ W/mK}$ ).

DUPLEX 10000–11000 Multi are frame construction, casing is made of painted metal sheet (colour RAL 9006) with 45 mm mineral wool insulation with heat transfer coefficient ( $\lambda = 0,037 \text{ W/mK}$ ).

### DUPLEX Multi ventilation units meet the requirements of the most stringent European standards:

- Casing properties according to EN 1886
- EC motors according to ErP 2015
- SFP < 0,45 W/(m<sup>3</sup>/h) according to PassivHaus\*
- Hygienic requests according to VDI 6022
- Commission regulation (EU) requirements No. 1253/2014 (Ecodesign)\*



### Advantages of DUPLEX Multi units:

- New design of ventilation units with excellent parameters
- Great thermal insulation of the casing (class T2)
- Reduced thermal bridging (class TB1/TB2 \* \*)
- Compact dimensions
- Very flat unit suitable for ceiling-suspended installation
- Ease of installation
- Variable configuration of discharge ports
- Unified dimensions of ports
- Optional versions with a bypass and circulation damper
- Horizontal floor-standing up to 11 000 m<sup>3</sup>/h, ceiling-suspended types up to 8 000 m<sup>3</sup>/h and floor-standing flat types up to 6 500 m<sup>3</sup>/h
- High efficiency fans – SFP < 0,45 W/(m<sup>3</sup>/h)\*
- High heat recovery efficiency of the counterflow heat exchanger – up to 93 %
- Integrated control system including temperature sensors
- Integrated web server (aMotion regulation)
- Comprehensive design software

\* in the defined working area

\*\* TB1 for 500–8000 Multi  
TB2 for 10000–11000 Multi



500 to 11000 Multi

### AVAILABLE MODIFICATIONS (CAN BE COMBINED)

- |     |                                  |       |                                   |
|-----|----------------------------------|-------|-----------------------------------|
| – B | with in-built bypass damper      | – T   | with in-built hot-water heater    |
| – C | with in-built circulation damper | – CHF | with in-built direct chiller      |
| – C | with in-built electrical heater  | – CHW | with in-built water-based chiller |

### OPERATING MODES OF DUPLEX MULTI UNITS

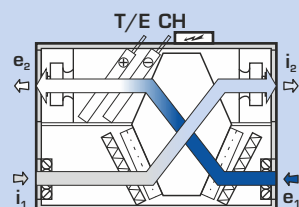

Ventilation with heat recovery with re-heating (with cooling)

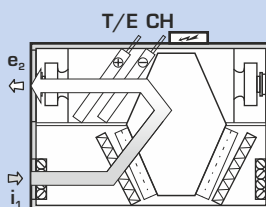

Circulation heating or cooling

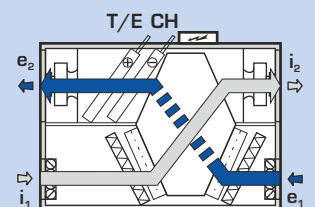

Ventilation without heat recovery (via bypass)

- ➔ e<sub>1</sub> ... Fresh outdoor air suction  
⇨ e<sub>2</sub> ... Fresh filtered air outlet

- ⇨ i<sub>1</sub> ... Exhaust air suction  
⇨ i<sub>2</sub> ... Exhaust air outlet

- T/E... Central heating / electrical heater connection  
CH ... Cooling connection

### SELECTION SOFTWARE



For the detailed design of DUPLEX series units, accessories and control systems we recommend using our dedicated design software. You can find it on our website at [www.atrea.eu](http://www.atrea.eu) or request a CD at our office.



UNIT VENTILATORS & HEAT RECOVERY

ATREA s.r.o., Čs. armády 32  
466 05 Jablonec n. Nisou  
Czech Republic



[www.atrea.eu](http://www.atrea.eu)

Phone: +420 483 368 111  
Fax: +420 483 368 112  
E-mail: [atrea@atrea.eu](mailto:atrea@atrea.eu)

# PERFORMANCE GRAPHS

## DUPLEX MULTI

DUPLEX Multi		500	1000	1500	2500	3500	5000	6500	8000	10000	11000
Supply air - max. <sup>1)</sup>	m <sup>3</sup> h <sup>-1</sup>	660	1 200	2 200	3 400	4 600	6 400	7 600	9 600	11 100	13 050
Extraction air - max. <sup>1)</sup>	m <sup>3</sup> h <sup>-1</sup>	670	1 150	1 800	3 200	4 200	6 350	7 500	9 100	10 700	12 300
Max. airflow according to ErP 2018 <sup>5)</sup>	m <sup>3</sup> h <sup>-1</sup>	550	850	1 600	2 350	2 800	4 250	5 000	5 700	7 700	8 300
Heat recovery efficiency <sup>2)</sup>	%	up to 93 %									
Number of versions and positions	-	see table „Mounting positions“, page 4									
Weight <sup>3)</sup>	kg	80-110	95-130	200-280	290-370	320-390	370-450	480-560	580-670	1170-1280	1230-1350
Max. power input	kW	0,3	0,7	1,2	2,6	4,5	6,7	7,3	9,3	10,7	10,8
Voltage	V	230	230	230	400	400	400	400	400	400	400
Frequency	Hz	50									
Revolutions - max.	min <sup>-1</sup>	4 300	3 350	2 920	3 000	2 980	2 700	2 820	2 570	2 570	2 130
Heating output E low - max. <sup>5)</sup>	kW	1,8	1,8	2,1	4,2	7,2	7,2	9,9	9,9	-	-
Heating output E high - max. <sup>5)</sup>	kW	-	-	4,2	8,4	10,8	12,6	14,7	14,7	-	-
Heating output T - max. <sup>4)</sup>	kW	5	14	22	30	42	51	71	88	95	100
Cooling output CHW - max. <sup>4)</sup>	kW	4	8	16	22	30	42	56	62	65	70
Cooling output CHF - max. <sup>4)</sup>	kW	3	6	10	13	25	37	41	50	60	65

<sup>1)</sup> Maximum flow rate through units at zero external pressure

<sup>2)</sup> According to air volume

<sup>3)</sup> Depending on equipment

<sup>4)</sup> Depending on register type, liquid and flow rates

<sup>5)</sup> For detailed information please use our DUPLEX selection software.

## PERFORMANCE SUMMARY

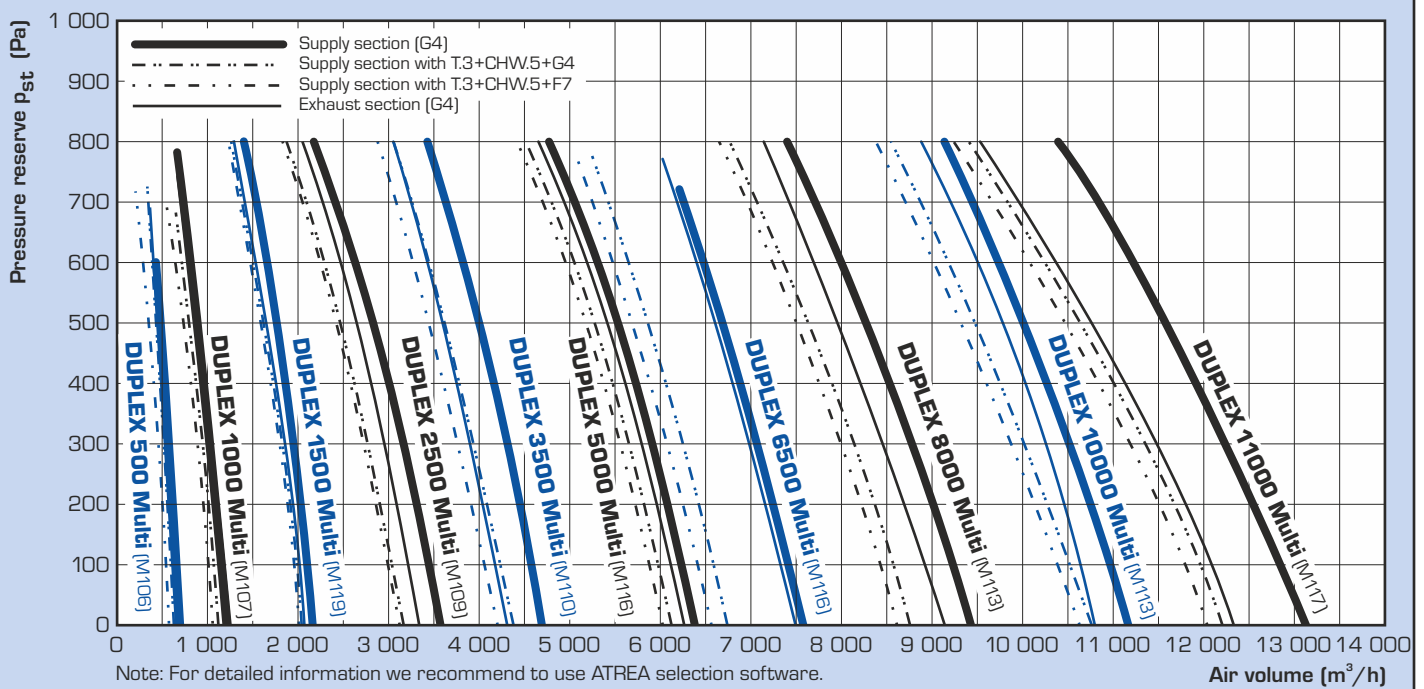

## HEAT RECOVERY EFFICIENCY

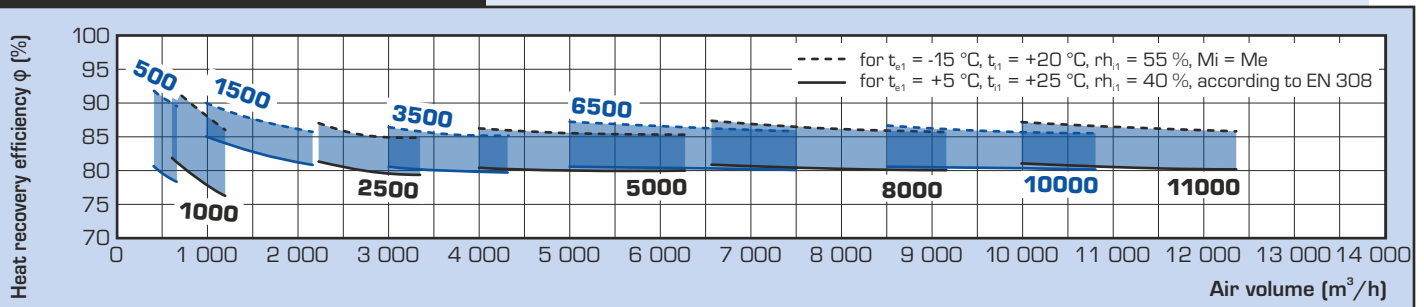

## HEATING AND COOLING PERFORMANCES

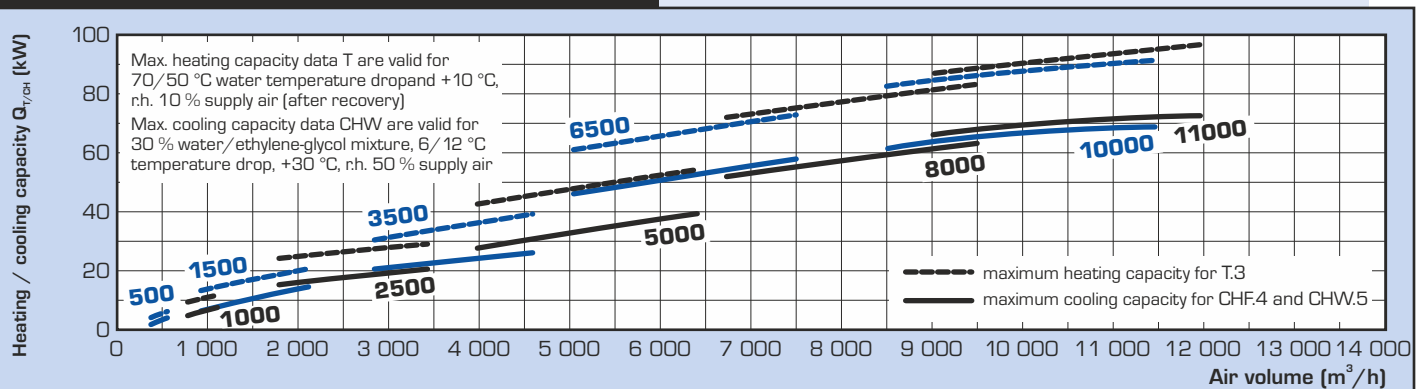

## BASIC DIMENSIONS

### FLOOR-STANDING (front view) Multi 500 to 8000

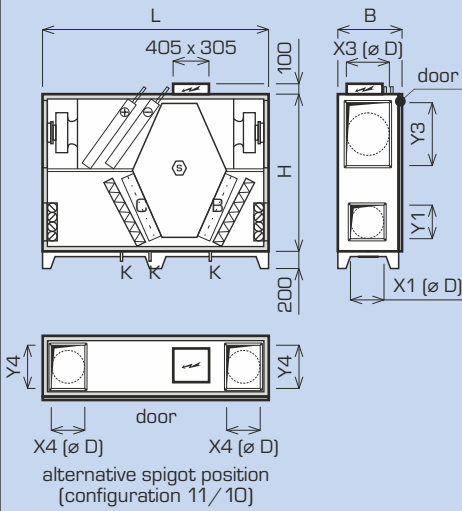

### Multi 10000 to 11000

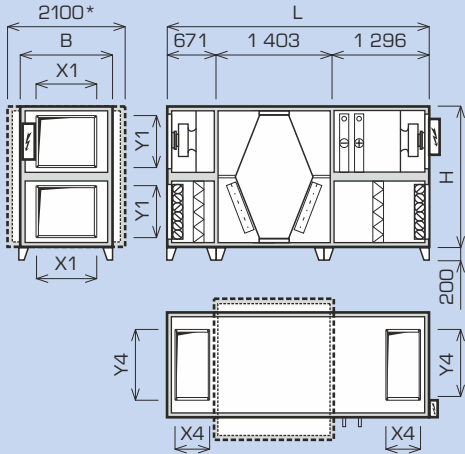

\* dimension only for DUPLEX 11000 Multi

### CEILING-SUSPENDED (top view) Multi 500 to 8000

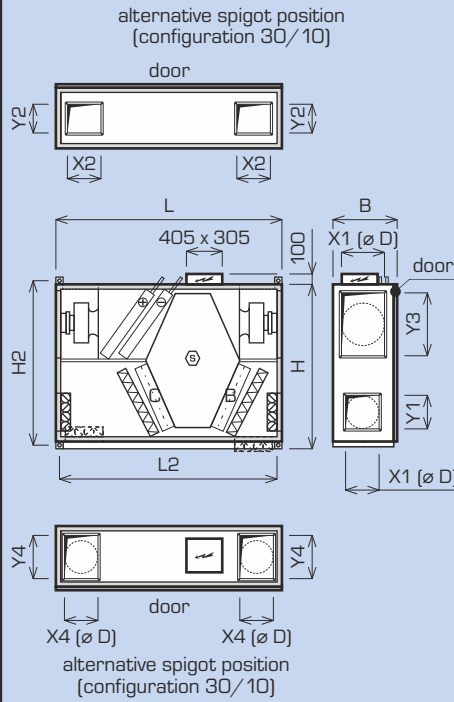

### Multi 8000

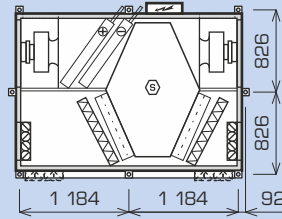

### FLOOR-STANDING FLAT (top view) Multi 1500 to 6500

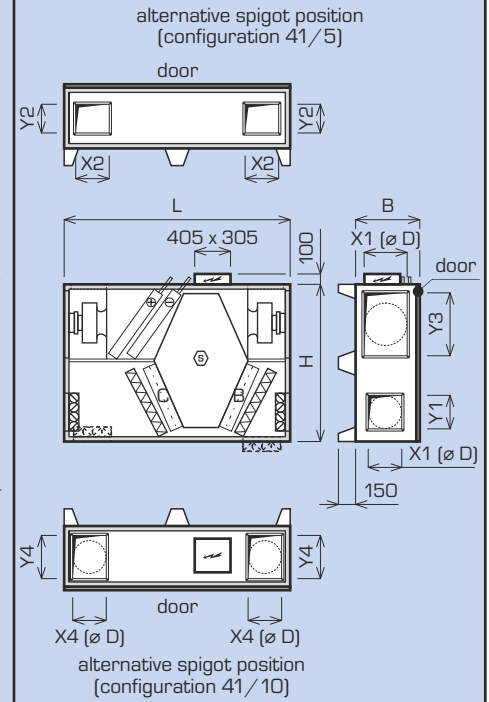

DUPLEX Multi		500	1000	1500	2500	3500	5000	6500	8000	10000	11000
dimension H	mm	765	970	1 600	1 600	1 600	1 600	1 600	1 600	1 795	1 795
dimension H2	mm	715	920	1 650	1 650	1 650	1 650	1 650	1 650	-	-
dimension B	mm	384	384	455	580	665	885	1 065	1 295/1 390*	1 620	1 620
length L	mm	1 600	1 800	2 300	2 300	2 300	2 500	2 500	2 500	3 370	3 370
length L2	mm	1 652	1 852	2 270	2 270	2 270	2 470	2 470	see diagram	-	-
condensate drain	mm	ø 22			ø 32						
<b>Connecting ports</b>											
dimension X1 × Y1 (standard e <sub>1</sub> , i <sub>1</sub> ), D	mm	ø 200	ø 250	ø 315	300 × 400	400 × 400	500 × 500	500 × 500	700 × 500	900 × 710	900 × 710
dimension X2 × Y2 (atyp e <sub>1</sub> , i <sub>1</sub> ), D	mm	ø 200	ø 250	400 × 200	300 × 400	400 × 400	500 × 500	500 × 500	500 × 700	-	-
dimension X3 × Y3 (standard e <sub>2</sub> , i <sub>2</sub> )	mm	200 × 250	200 × 350	ø 315	450 × 710	500 × 710	710 × 710	900 × 710	900 × 710	-	-
dimension X4 × Y4 (atyp e <sub>2</sub> , i <sub>2</sub> )	mm	-	-	-	250 × 355	250 × 400	355 × 630	355 × 800	355 × 900	400 × 1200	400 × 1200

\* For DUPLEX 8000 Multi in configuration 30/x. For detailed information please use our ATREA selection software.

## TYPES AND DIMENSIONS OF CONNECTING PORTS

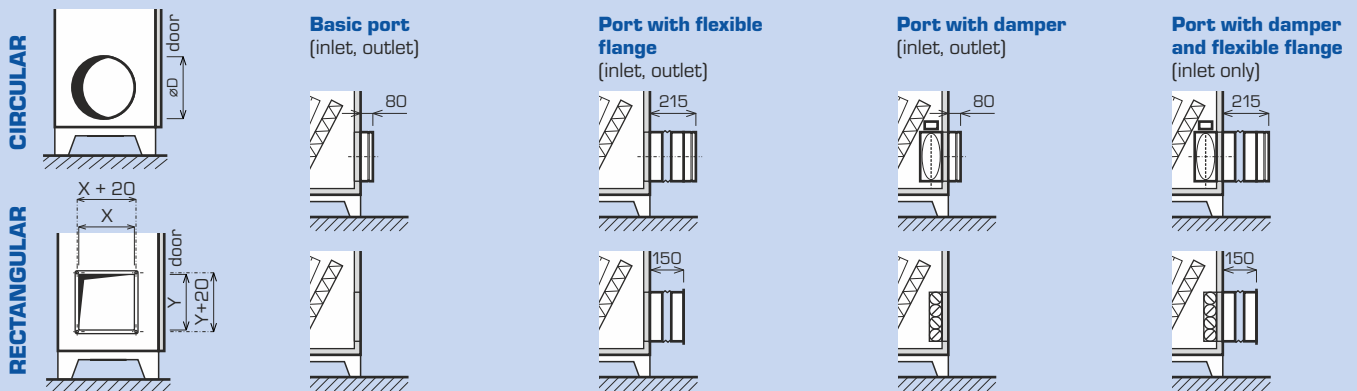

# INSTALLATION AND VERSIONS

## INSTALLATION VERSIONS AND CONNECTING PORTS

DUPLEX 500 to 11000 Multi units are available in a range of versions to facilitate their installation in the machine room. This significantly increases options to install DUPLEX Multi units in cramped spaces.

For structural reasons and to ensure condensate drain it is not possible to have all units available in all mounting positions. Detailed drawings are shown in the summary table "Mounting positions".

DUPLEX Multi units are characterised by a wide range of accessories – the ports may be optionally fitted with flexible flanges and inlet ports may have shut-off dampers if required.

## MOUNTING POSITIONS

### FLOOR-STANDING HORIZONTAL POSITION

Multi 500 to 11000

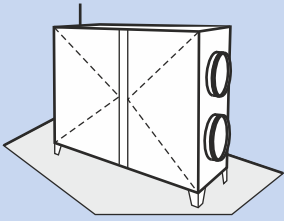

configuration 10/0 to 11/10 – door-side view (up to 8 configurations in total)

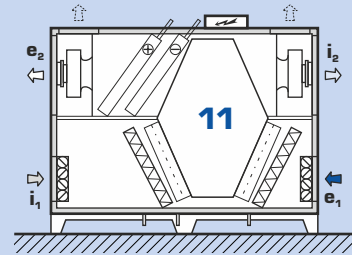
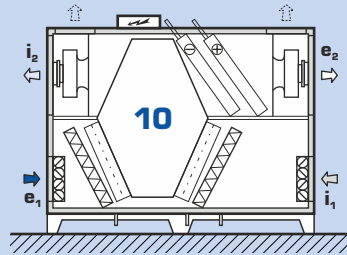

### CEILING-SUSPENDED POSITION

Multi 500 to 8000

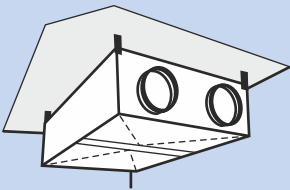

configuration 30/0 to 31/15 – top view (up to 32 configurations in total)

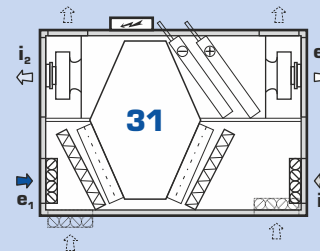
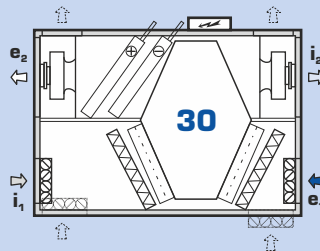

### FLOOR-STANDING FLAT POSITION

Multi 1500 to 6500

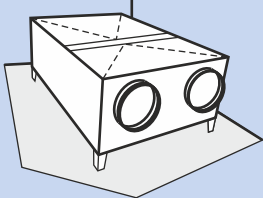

configuration 40/0 to 41/15 – top view (up to 32 configurations in total)

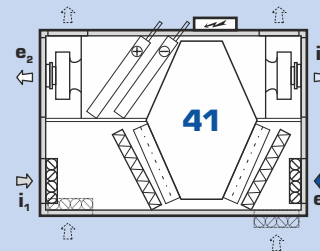
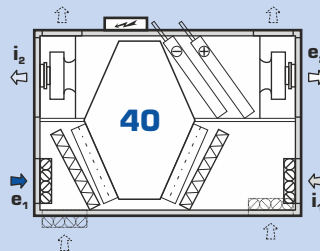

500 and 1000 Multi units are available in following configurations:

- horizontal: 10/0, 11/0
- ceiling - suspended: 30/0, 30/1, 30/4, 30/5, 31/0, 31/1, 31/4, 31/5

For more detailed technical information check out ATREA selection software.

## OTHER CONFIGURATIONS OF DUPLEX MULTI

### UPRIGHT POSITION

DUPLEX Multi-V 1500 to 8000

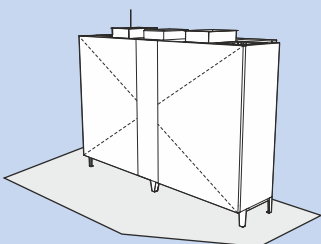

### ROOFTOP UNITS - FLAT

DUPLEX Multi-N 1500 to 11000

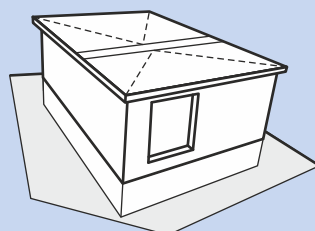

For detailed information please see separate technical catalogues.

## HANDLING SPACE

DUPLEX units must be installed with the prescribed handling space around the unit in mind. Below the unit at least 150 mm must be left to install the DN 32 condensate drain line. This line must run through a U-bend at least 150 mm high into a sewer. This space is easily provided when the steel supporting feet supplied as standard are used. Handling space in front of the unit must be maintained for opening the front door, replacing filters and providing servicing and installation access to each unit part.

Each drawing shows the minimum handling space. In addition, each unit must have the minimum handling space of 600 mm from the side of the control system electric switchboard according to CSN. Units with a heating or cooling control manifold must have free space from the side of the manifold, too.

### Handling space in front of the door

#### Floor-standing horizontal 500-8000 Multi

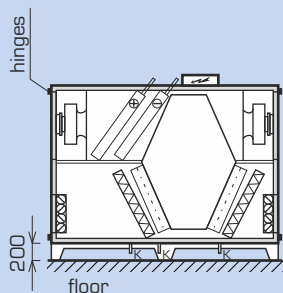

#### Floor-standing horizontal 10000-11000 Multi

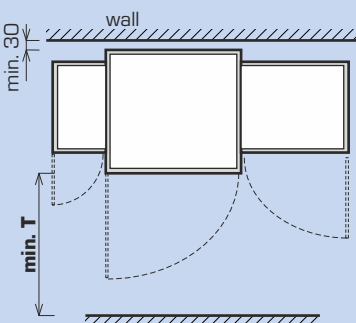
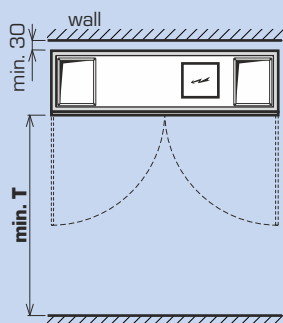
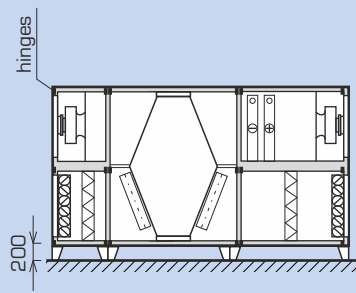

#### Floor-standing flat 1500-6500 Multi

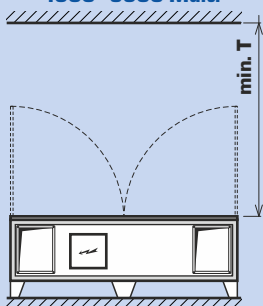

#### Ceiling-suspended 500-8000 Multi

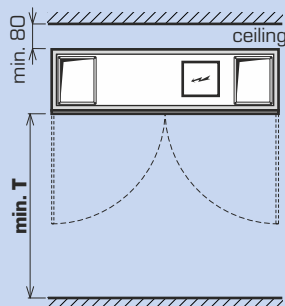

### Handling space for accessories

#### Control modules

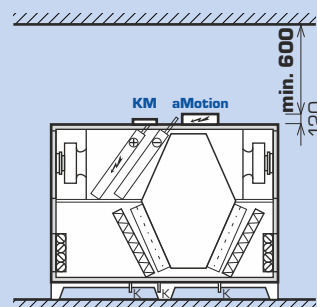

#### Control manifolds

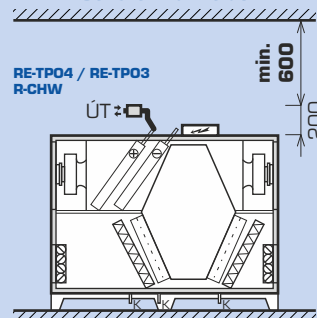

Typ	standard door T (mm)	hingeless door T (mm)
DUPLEX 500 Multi	800	500
DUPLEX 1000 Multi	900	500
DUPLEX 1500 Multi	1 200	500
DUPLEX 2500 Multi	1 200	600
DUPLEX 3500 Multi	1 200	680
DUPLEX 5000 Multi	1 150	900
DUPLEX 6500 Multi	1 150	1 100
DUPLEX 8000 Multi	1 320	1 300
DUPLEX 10000 Multi	-	1 600
DUPLEX 11000 Multi	-	1 600

## ACOUSTIC POWER $L_w$ AND ACOUSTIC PRESSURE $L_{D_3}$

Type	Working point	Acoustic power $L_w$ [dB(A)]					Acoustic pressure $L_{D_3}$ [dB(A)] at distance of 3 m
		inlet $e_1$	inlet $i_1$	outlet $e_2$	outlet $i_2$	unit	
DUPLEX 500 Multi	500 m <sup>3</sup> /h (200 Pa)	53	66	80	82	59	38
DUPLEX 1000 Multi	1 000 m <sup>3</sup> /h (200 Pa)	66	65	85	86	62	42
DUPLEX 1500 Multi	1 500 m <sup>3</sup> /h (200 Pa)	61	61	86	86	64	43
DUPLEX 2500 Multi	2 500 m <sup>3</sup> /h (200 Pa)	59	55	79	79	70	49
DUPLEX 3500 Multi	3 500 m <sup>3</sup> /h (200 Pa)	60	59	91	88	70	49
DUPLEX 5000 Multi	5 000 m <sup>3</sup> /h (200 Pa)	68	67	91	93	78	58
DUPLEX 6500 Multi	6 500 m <sup>3</sup> /h (200 Pa)	70	71	95	95	76	55
DUPLEX 8000 Multi	8 000 m <sup>3</sup> /h (200 Pa)	75	74	99	96	69	49
DUPLEX 10000 Multi	9 000 m <sup>3</sup> /h (200 Pa)	66	67	98	97	74	53
DUPLEX 11000 Multi	10 000 m <sup>3</sup> /h (200 Pa)	63	64	88	88	73	52

# MODIFICATIONS

## DUPLEX MULTI - BASIC UNIT



### Basic configuration

#### DUPLEX 500-8000 Multi

The compact unit consists of supply and exhaust free-wheel fans with electric motors in anti-vibration mounting, removable counterflow air-to-air heat recovery core assembled from thin plastic plates, removable G4, M5 or F7 supply and exhaust air filters, and a condensate pan with flexible hose. A front door enables easy access to all built-in components and filters.

#### DUPLEX 9000-11000 Multi

The unit consists of 3 separate sections:

- 1 - supply free-wheel fan with electric motors in anti-vibration mounting, removable supply filter G4, M5 or F7
- 2 - cross-flow heat recovery exchanger with an electric motor, a belt pulley and a belt
- 3 - exhaust free-wheel fan with electric motors in anti-vibration mounting, removable exhaust filter G4, M5 or F7

A front door enables easy access to all built-in components and filters.

The units meet requirement in accordance with Commission regulation (EU) No. 1253/2014 (Ecodesign) in the defined working area

DUPLEX xxxx Multi



### Fans

All units are equipped with high-efficiency fans (ebm-papst and Ziehl Abegg) with free-running impellers and backward curved blades. Ventilators of DUPLEX 500 to 11000 Multi units meets the requirements of the ErP 2015.

Me.xxx; Mi.xxx



### Heat recovery exchanger

The only heat recovery core type S7 or S3 made of plastic in counterflow arrangement with high efficiency - up to 93 %.

Sx

## DUPLEX MULTI - MODIFICATION DESCRIPTION



### By-pass ("B")

By-pass of the plate heat recovery core on supply air side. By-pass consists of an opposed-blade damper and an actuator. It is fitted next to the recovery core inside the unit; it does not increase size of the unit. The standard actuator is BELIMO 24 V; other types are available upon request.

B.x



### Mixing damper ("C")

The mixing damper is used to mix exhaust and supply air. Circulation valve consists of an opposed-blade damper and actuator. It is fitted next to the recovery core inside the unit; it does not increase the size of the unit. The standard actuator is BELIMO 24 V; other types are available upon request.

C.x



### Hot water heating coil ("T")

Built-in water-to-air three-row (possibly five-row) heating coil; made of copper pipes and aluminum fins. Designed for systems up to 110 °C and 1,0 MPa. The coil is standardly equipped with flexible connection and a steam-gas capillary thermostat for freeze protection. Units in modification T (with heating coil) must be equipped with e, supply air shutoff damper; an actuator with spring-return function is recommended. A coil hydraulic kit for heating capacity control of RE-TPO4 or RE-TPO3 type can be supplied with the coil upon request.

T.x

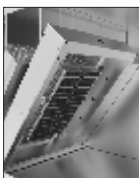

### Electric heating coil ("E")

Integrated electric heating coils consist of PTC (Positive Temperature Coefficient) cells; they are generally used to heat up supply air. By default, electric heating coils always include protective thermostats (operational as well as emergency with manual reset) and regulation module KM featuring power switching elements with so called "zero" switching function (SSR). Built-in electric heating coils are offered in the 500-8000 Multi units in two power options (basic and powerful). For more information please refer to the selection software DUPLEX.

E.x



### Direct expansion (DX) coil ("CHF")

A built-in coil made of copper pipes and aluminum fins, including a condensate pan with individual condensate drainage and a pressure switch for freeze alarm. Three- or four-row coils with various evaporate temperature are chosen depending on capacity required, refrigerant type and air parameters. Optionally it is possible to deliver double-circuit evaporator in division 1:1 or 1:2, or completely atypical with needed capacity.

CHF.x



### Chilled water cooling coil ("CHW")

A built-in coil made of copper pipes and aluminum fins, including a condensate pan with individual condensate drainage. Three- or five-row coils are chosen depending on capacity required, cooling medium type and air parameters. The cooling coil can be equipped with the R-CHW2 or R-CHW3 hydraulic kit on request.

CHW.x

## OTHER OPTIONAL ACCESSORIES (BASIC OVERVIEW)

Ke.xxx; Ki.xxx

### Shutoff damper e<sub>1</sub>; i<sub>1</sub>



Shutoff dampers standardly fitted with BELIMO actuators are located in the air inlet port. The following damper types are available:

- fresh air damper e<sub>1</sub> - mandatory for C modification (with mixing damper) and T modification (with heating coil)
- exhaust air damper i<sub>1</sub>

Fe.xxx; Fi.xxx

### Air filtration



All DUPLEX Multi units can be equipped with supply or exhaust air filtration of M5 or F7 class instead of standard G4 class. Pressure drop of the filter is then 50 to 100 Pa (clean filter) depending on air flow rate, unit type and dirt accumulated.

RE-TPO.x

### Heating coil hydraulic kit



Its function is to control heating capacity of a heating coil. It consists of a three-speed pump, two globe shutoff valves and connection pipes. Further equipment depends on the type:

- RE-TPO4 - four-way mixing valve with an actuator for digital control system
- RE-TPO3 - three-way mixing valve with an actuator for digital control system

R-CHW.x

### Cooling coil hydraulic kit



Its function is to control cooling capacity of a chilled-water cooling coil. It always consists of two globe shutoff valves and connection pipes. Further equipment depends on the type:

- R-CHW3 - three-way mixing valve with an actuator
- R-CHW2 - throttling valve with an actuator for digital control system

MFF

### Tube manometers



Accessory for filters for simple view of current pressure drop. The tube manometers are obligatory for hygienic unit design in accordance with the VDI 6022.

FK.x

### Spare cartridge filters



Replacement filter cartridges in different sizes based on the unit type. Available in G4, M5 and F7 filtration class.

### Delivery of disassembled unit

All units can be delivered dismantled on request. The unit is to be assembled by rivets and bolts directly on site, therefore the unit can be installed in inaccessible location. Casing insulation class T3, thermal bridging class TB2.

H.P

### Flexible connections



Round and rectangular ports can be equipped with flexible connections upon request.

TPO

### Hot water heating coil (TPO)



Separately supplied coil for installation into round duct. It is suitable for cramped locations, where it is impossible to put the coil inside the unit, as well as for rooftop units. The coil is standardly equipped with the steam-gas capillary thermostat. Capacities and diameters can be found in respective catalogue sheets.

### Electric heating coil (EPO-V)



Separately supplied heating coil to be fitted into round or rectangular duct. Capacities and diameters can be found in respective catalogue sheets.

CF.XXX

### Constant air flow and pressure



Manometers reading fan pressure together with controls, enables intelligent fan control of preselected airflow. This accessory assumes the unit is equipped with ATREA digital control system. Using a second manometer (optional accessory) in the supply air duct enables the user to control constant pressure in the supply duct.

EPO-V

### Electric preheaters EPO-V



EPO-V electric heating coils to provide the antifreeze protection of the heat recovery exchanger when equal-pressure ventilation is continuously required. It is installed inside a duct on the outdoor supply air side of the unit (e<sub>1</sub>). This accessory assumes the unit is equipped with ATREA digital control system.

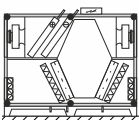

### Hingeless door

When needed it is possible to deliver door without standard hinges - than necessary manipulation space is reduced. DUPLEX 9000 and 11000 Multi are supplied hingeless standardly.

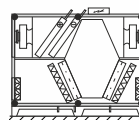

### External switchboard

It is possible to supply control module in external version with various cable length.

# CONTROLS





DUPLEX Multi units are delivered with basic control components or with complete control systems.

There are three types of control systems available (Basic, CPM and aMotion) according to customer needs and an application. The systems also include variety of sensors (temperature, humidity, air quality, CO<sub>2</sub>) for effective operation control.

## Features of the control systems

- selection of the most suitable and efficient control system at the lowest cost, depending on the particular application
- control system is integrated with the unit, most components are already wired and checked in factory, thus reducing the risk of incorrect wiring
- no control system project documentation is necessary for standard cases, standardized solutions can be used
- simple wiring, system simplicity, error indication
- qualified technical support and consulting

## SUMMARY OF DUPLEX MULTI CONTROL SYSTEMS

Type	Use	Controller
<b>“Basic” controls</b>	<ul style="list-style-type: none"> <li>- all electrical components are wired to a junction box terminal strip inside or outside the unit</li> <li>- standard components are fans, damper actuators, capillary freeze protection thermostat of hot water heating coil</li> <li>- more components are included upon customer's request (exact actuator type, sensors, thermostats, pressure switches etc.)</li> <li>- suitable for applications with separate delivery of control system; e.g. large buildings with central control system etc.</li> </ul>	<div style="border: 1px solid black; padding: 5px; margin-bottom: 5px;"> <p style="text-align: center;"><b>basic version</b> (fans, actuators, thermostats, pressure switches and others on request)</p> </div> <p style="text-align: center;">↑ ↓</p> <div style="border: 1px solid black; padding: 5px; margin-bottom: 5px;"> <p style="text-align: center;">Supervisory control system</p> </div>
<b>“CPM” controls</b>	<p><b>Standard functions</b></p> <ul style="list-style-type: none"> <li>- EC fan speed control (stepless)</li> <li>- automatic by-pass damper position</li> <li>- frost protection of heat exchanger</li> <li>- switching of electric or water heater</li> <li>- input for external switch</li> <li>- inlet and outlet shut-off damper control</li> <li>- minimum and maximum fan speed preselection</li> <li>- analogue input (0-10 V) for air quality sensor (CO<sub>2</sub>, RH)</li> <li>- outputs for controlling electrical preheater and heater (pulse switched 10 V) or water heater (controlled by 0-10 V signal)</li> <li>- outputs for controlling cooling (direct or water), eventually heat pump</li> </ul> <p><b>Controller CPM</b></p> <ul style="list-style-type: none"> <li>- fully graphic touchscreen</li> <li>- weekly program</li> <li>- „party” mode</li> <li>- „holiday” mode</li> <li>- filter change notice</li> <li>- automatic operation based on constant signal - e.g. constant pressure</li> </ul> <p><b>Controller CP 10 RA</b></p> <ul style="list-style-type: none"> <li>- rotatable controller</li> </ul>	<div style="text-align: center;">  <p><b>CPM controller</b> with touchscreen display</p> </div> <div style="text-align: center; margin-top: 20px;">  <p><b>CP 10 RA</b> with mechanical knob</p> </div>
<b>“aMotion” controls</b>	<p><b>Standard aMotion control functions</b></p> <p><b>Elementary aM-CE basic module</b></p> <ul style="list-style-type: none"> <li>- EC fans speed control (according to selected mode)</li> <li>- Automatic heat and cool recovery control (by-pass control)</li> <li>- Evaluates and prevents all emergency conditions according to the measured values</li> <li>- Possibility of setting basic and user scenes and weekly calendars to select modes, power, temperatures and other functions</li> <li>- Ethernet connection for communication over the Internet</li> <li>- Inputs for external signals - control e.g. from kitchens, toilets and similar</li> <li>- Possibility of connecting air quality sensors (e.g. CO<sub>2</sub> concentration or relative humidity) either by contact, 0-10V voltage, or via the bus.</li> <li>- Outputs for continuous control of electric preheater and heater (pulse switched 10 V)</li> <li>- Possibility of connecting up to two controllers of different types</li> <li>- Connection to supervisory control system via Modbus TCP protocol</li> </ul> <p><b>Legendary aM-CL advanced module (with all functions from Elementary aM-CE module and additional options below)</b></p> <ul style="list-style-type: none"> <li>- Control of systems with VAV boxes</li> <li>- Control of systems with heat sources (heat pumps, heat accumulators etc.)</li> <li>- Communication by BACnet protocol over the bus</li> <li>- Possibility of connecting more than two controllers</li> <li>- More than 4 external bus elements (controllers, CO<sub>2</sub> sensors, outdoor temperature sensors,...)</li> <li>- Multiple adjustable scenes (more than 10)</li> <li>- More than 2 user calendars</li> <li>- More than 4 users (excluding service access)</li> </ul> <p><b>Additional module aM-IO18</b></p> <ul style="list-style-type: none"> <li>- Inputs for 4 external signals - control from kitchens, toilets and similar</li> <li>- Hot water heater control (0-10 V)</li> <li>- Control of circulation modes</li> </ul> <p><b>Additional module aM-IO12</b></p> <ul style="list-style-type: none"> <li>- Control of cooling (direct and water) and heat pumps</li> <li>- Rotary regenerator</li> </ul> <p><b>Additional aM-XCF</b></p> <ul style="list-style-type: none"> <li>- Unit control based on flow measurement</li> </ul> <p><b>Additional RD-K module</b></p> <ul style="list-style-type: none"> <li>- Additional inputs and outputs significantly expanding the control system functionality</li> </ul> <p><b>BACnet / KNX converter</b></p> <ul style="list-style-type: none"> <li>- Connection to the superior system via BACnet or KNX protocol</li> </ul>	<p><b>aTouch (touchscreen)</b></p> <div style="text-align: center;">  </div> <p><b>aDot (touchscreen)</b></p> <div style="text-align: center;">  </div> <p><b>aSpace (internet interface)</b></p> <div style="text-align: center;">  </div>